

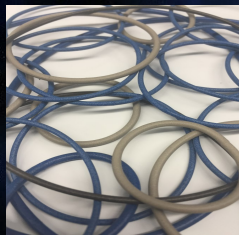

EAST COAST SHIELDING

EMI SHIELDING PRODUCTS



1090 Route 519

Johnsonburg, NJ 07846

Ph.: (908) 852 - 9160

Fax: (908) 852 - 9163

sales@eastcoastshielding.com

www.eastcoastshielding.com

Making Quality Products Since 2007

Table of Contents

1	About East Coast Shielding
2-5	Shielding Glossary
6	RoHS Compliance Statement
7-8	Custom Gasket Material
9-14	ECS Connector Gaskets
15-21	Bonded O-Rings
22-25	ECS1 Series—Knitted Wire Mesh
26-28	ECS2 Series—Conduct-O-Seal Combo Gaskets
29-33	ECS3 Series—Conduct-O-Elastomer
34-40	ECS4 Series—Conduct-O-Seal Wire Oriented Silicone
41	ECS5 Series—Conduct-O-Mesh Tape
42	ECS6 Series - Conduct-O-Woven Aluminum
43-47	ECS180 Series—Optical Filters for Electronic Displays
48-49	ECS200 Series—Conduct-O-Foam Metalized Fabric Over Foam
50-51	ECS300 Series—Non Conductive Silicone Rubber & Elastomers
52-53	ECS400 Series—Honeycomb Aluminum Vent Panels
54	ECS2000 Series—Conduct-O-Bond Conductive Adhesive
55	ECS5000 Series—Conduct-O-Bond Adhesive
56	ECS Board Level Shielding

EAST COAST SHIELDING

We are a small, family run business that now supply companies worldwide with out EMI/RFI products. The owner comes from an EMI Shielding/Silicone background. We have over 25 years of experience in the industry and have been in business for the past 10 years.

East Coast Shielding is a custom manufacturer of high performance EMI gaskets for industrial applications. Used for electronics, enclosures and housings, aerospace, automotive, medical, military, packaging and other industrial applications. Our EMI gaskets provide superior shielding coupled with high performance seal and protection. We have earned the reputation for providing our clients with solutions - not just products - to their manufacturing challenges. Our expert team listens to your needs, recommending the best materials, parts and manufacturing process to provide you with an effective solution for your application. East Coast Shielding specializes in designing custom parts for difficult tasks and unique applications.

EMI (electromagnetic interference) shielding blocks electromagnetic fields using shields, or barriers, of conductive or magnetic materials. It is commonly used to isolate electrical and electronic devices, wires and cables from environmental “noise” that can interfere with the performance of the equipment. RFI shielding is used to block radio frequency electromagnetic interference in products that are used to transmit data

Our Emi gaskets are manufactured to the highest standards to meet your exact specifications. We have the capabilities to manufacture your gaskets in a wide range of sizes to meet your shielding requirements. Our team will work with you to provide a custom solution at a cost-effective price—high performance products coupled with a competitive price provide superior value for each project.

At East Coast Shielding, we are committed to developing new applications, techniques and new gasket & die-cut product designs to provide you with the highest quality solutions for your EMI applications. We are proud of our reputation for innovation, quality and superior customer service. Call today to see how we can help you.



EAST COAST SHIELDING

SHIELDING GLOSSARY

AF - Audio Frequency - Components of a signal or noise having frequencies in the 15 Hz - 20 kHz range.

Air Filters, Shielded - Used to permit ventilating shielded rooms and cabinets while removing dust and other air suspended particles. The filter also provides a shield to RF energy, which would otherwise leak in or out of an enclosure. Air filters are often used where wave-guide-beyond-cut-off honeycomb shielding would otherwise be used.

Anechoic Chambers (rooms) - A lined metallic enclosure that isolates the electromagnetic ambient environment while providing low internal reflections. These chambers, sometimes called microwave dark rooms, are usually large rooms lined with absorbing materials to reduce R-F reflections.

Attenuation - The difference in dB [$20 \log_{10} (V_{\text{input}}/V_{\text{output}})$] of a device (e.g., a power line filter PLF) vs. frequency measured in a system of unknown (e.g., in-situ) or defined input and output impedances.

BeCu - Beryllium Copper - Among other applications, BeCu is used extensively for shielding finger stock gaskets because of its maximum spring properties of strength and fatigue resistance.

Biconical Antenna - A broadband dipole antenna used to measure and produce electric fields from approximately 30 MHz to 300 MHz.

Bilog Antenna - A combination of a biconical and a log periodic antenna with an automatic crossover network. It has a frequency range from about 26 MHz to 2 GHz.

Common Mode - Signals that are identical in amplitude and phase at both inputs; the potential or voltage that exists between neutral and ground. Most electronic equipment requires it to be as close to 0 V and not to exceed 1&Mac218;2 V.

Common-Mode Current - The component of the signal current that induces electric and magnetic fields; these fields do not cancel each other. For example, in a circuit with one outgoing signal conductor and one ground conductor, the common-mode current is the component of the total signal current that flows in the same direction on both conductors. It is the primary source of EMI in many electronic systems.

Common-Mode Interference - Interference that appears between signal leads or the terminals of a measuring circuit and ground.

Common-Mode Rejection Ratio - The ratio of the common-mode interference voltage at the input of a circuit to the corresponding interference voltage at the output. A high ratio is desirable. The ratio expresses the capability of the device to reject the effect of a voltage that is applied simultaneously to both input terminals.

Conductive Elastomer - An elastomer-containing metal powder or small flakes for bonding metal parts to achieve a defined shielding effectiveness.

Conducted Emission - The potential EMI-generated inside equipment and carried through the I/O lines, the control leads, or power lines.

Conducted Susceptibility - The EMI that couples from the outside of equipment to the inside over the I/O cables, signal leads, or power lines.

Current Probe - An EMI-measuring sensor that clamps onto a wire, wire pair, coaxial line, or cable harness. Snap-on current probes measure the normal-mode current in a wire pair, coax, or wire bundle. They help locate and quantify ground loops.

dB = Decibel - A unit of the logarithm of a ratio measurement = $10 \log_{10} (P1/P2) = 20 \log_{10} (V1/V2) - 10 \log_{10} (Z2/Z1)$.

Dipole Antenna - Antenna with the gain, pattern, and impedance defined at and near resonance of one-half wavelength. The antenna is split at its electrical center for connection to a transmission line. The radiation pattern is maximum at right angles to the axis of the antenna.

EAST COAST SHIELDING

SHIELDING GLOSSARY

Electromagnetic Compatibility - The capability of equipment to be operated in its intended operational environment at designed levels of efficiency without causing electromagnetic interference.

Electromagnetic Interference (EMI) - Any conducted radiated or magnetically induced voltage which degrades, obstructs, or repeatedly interrupts the desired performance of electronic equipment.

Electromagnetic Spectrum - The entire range of wavelengths or frequencies of electromagnetic radiation extending from gamma rays to the longest radio waves and including visible light.

EMC = Electromagnetic Compatibility - Operations of equipment and systems in their installed environments which cause no unfavorable response to or by other equipment and systems in the same environment.

EMI = Electromagnetic Interference - When an electrical disturbance from a natural phenomena (e.g., lightning or ESD) or an electrical/electronic device or system causes an undesired conducted or radiated response in a victim. EMI is the opposite of EMC.

EMI Filter - A circuit or device containing series-inductive and parallel-capacitive components that provide a low impedance path for high-frequency noise around a protected circuit.

Emission, EMI - The unintentional or undesired exiting of potentially interfering electromagnetic energy from electrical/electronic sources.

Faraday Shield - A conductive material used to contain or control an electric field. It is placed between the primary and secondary windings of a transformer to reduce coupling capacitance and common-mode noise. The shield provides electrostatic shielding while passing electromagnetic waves. Ground is not needed.

Ferrites, EMI - Powdered magnetic (permeable) material in the form of beads, rods, and blocks used to absorb conducted interference on wires, cables, and harnesses.

Ferrite Material - Made by calcining a combination of metal oxides sintered into tiles. Material only a few millimeters thick absorbs low frequencies. Tiles may be used with dielectric materials or as a hybrid combination with dielectric pyramids.

Filter - A device for blocking the flow of EMI current while passing the desired 50/60/400-Hz current. In communications circuits, it suppresses unwanted frequencies, noise, or separates channels.

Filters, EMI/RFI - Filters designed for power-line and/or signal line applications to pass a defined band and reject emissions above the cutoff frequency.

Finger Stock - A beryllium copper, electrical gasket used to bond metal panel members on doors, sills or covers designed to accommodate many openings and closings with limited aging effects.

Gaskets, Electrical - Gaskets are used to fill and electronically bond and seal leaky apertures between mating panel member parts in order to maintain a minimum shielding effectiveness over a defined frequency spectrum.

Honeycomb, EMC Airflow - A hexagonal cell configuration (honeycomb) to permit smooth airflow into and out of shielded enclosures while also blocking electromagnetic radiation leakage.

Horn Antenna - A microwave antenna made by flaring out the end of a circular or rectangular waveguide into the shape of a horn; for radiating radio waves into space.

Insertion Loss - The ratio between the power received at a specified load before and after the insertion of a filter at a given frequency. It is an indication of the attenuation provided by a filter.

EAST COAST SHIELDING

SHIELDING GLOSSARY

IEEE/EMC - The EMC society within the IEEE (Institute of Electrical Engineers).

Log Periodic Antenna - A broadband antenna. The electrical lengths and element spacings are chosen so the bi-directional radiation pattern, impedance, and other antenna properties are repeated for several frequencies. The bandwidth is approximately the ratio of the longest dipole element to the shortest.

Loop Antenna - An antenna consisting of one or more complete turns of a conductor; usually tuned to resonance by a variable capacitor connected to the terminals of the loop. It measures magnetic-field strengths at frequencies -30 kHz.

Method of Moments - Equations for numerically computing electromagnetic fields.

MHz - Megahertz - 1000 kHz = 10⁶ Hz

Ohm's Law - The mathematical relationship between current (I), voltage (V), and resistance (R) where $V=I \times R$. If any of the two variables are known, the third can be calculated.

Parasitic Capacitance - The capacitive leakage across a component such as a resistor, inductor, filter, isolation transformer, or optical isolator that adversely affects high-frequency performance.

Permeability - The extent to which a material can be magnetized; often expressed as the parameter relating the magnetic-flux density induced by an applied magnetic-field intensity.

RADHAZ Meter = Radiation Hazard Meter - A hand-held, battery operated, broad-band receiver designed to measure the electric-power density (electric-field strength) from typically 10 kHz to about 18 GHz in two or three bands.

Radiated Emission (RE) - The potential EMI which radiates from escape-coupling paths such as cables, leaky apertures, or inadequately shielded housings.

Radiated Susceptibility - Undesirable EMI radiated into equipment from outside electromagnetic sources.

Radiation - The outward flow of energy from any source in the form of electromagnetic energy.

Radio Frequency - A frequency at which coherent electromagnetic radiation of energy is useful for communications. Radio frequencies are designated as very low: - 30 kHz, low: 30 to 300 kHz, medium: 300 to 3,000 kHz, high: 3 to 30 MHz, very high: 30 to 300 MHz, ultra-high: 300 to 3,000 MHz, super high: 3 to 30 GHz, and extremely high: 30 to 300 GHz.

Radio Frequency Interference (RFI) - A high frequency, cyclic series of spikes or noise injected onto an electrical line by means of radio wave energy or by a piece of equipment connected to the line. Exists when either the transmitter or receiver is carrier operated (has an antenna), causing undesired responses to or from other electronic equipment or systems.

RFI/EMI Filters - Low-pass filters designed for power lines and/ or control and signal leads.

Ripple - The AC component of the output of a DC signal. The term typically refers to the residual line-frequency-related AC part in the output of a DC power supply that arises as a result of incomplete or inadequate filtering. The amount of filtering depends on the ripple frequency and the load resistance. As load resistance decreases, more filtering is required.

Shielded Cables - To protect EMI from entering or exiting a cable, shield(s) may be added. Braids and foils are the most popular shields.

Shielding Effectiveness - The relative capability of a shield to screen out undesirable electric and magnetic fields and plane waves. The measurement is the ratio of the signal received without the shield to the signal received inside the shield.

EAST COAST SHIELDING

SHIELDING GLOSSARY

Shielding Gasket - A material that maintains shielding effectiveness across a seam or gap in an electronic enclosure. It is made from a variety of materials including fabric-wrapped foam, wire mesh, stamped metal, and elastomer.

Shielded Room - A room made free from EMI by applying shielding to the floor, walls, and ceiling, and by suppressing interference entering through the power lines. Typical construction shields from 70 dB to 140 dB from 10 kHz to 10 GHz.

Shielded Windows - Shielding accomplished by using a thin conducted film on the glass, or a fine-wire mesh or metalized open-mesh textile.

Shielding (Electrical Shielding) - A process of preventing radiation from coupling into or out of defined areas or regions. Shielding materials are always metals, metalized plastics (conductive coatings), or conductive composites.

Shielding Fabrics - Fabrics made of (1) metal threads or yarn, or (2) conductive-coated yarn, woven to form a shielded fabric.

Shielding Foils and Sheets - Thin sheets of metallic foil are used for both shielding and grounding. Foil sheets are usually adhesive backed to line nonconductive boxes, cabinets, and walls. They also make low-impedance ground plates.

Shielding Gaskets - Electrical gaskets used to bond to pieces of metal or to fill voids between mating metal members to block aperture leaks.

Shielding Vents - Used for HVAC or simple ventilation of shielded products, cabinets, enclosures, and rooms. Some provide high shielding, such as honeycomb, while others provide air filtering, as well.

Shielding Windows - Metal mesh screen or thin films deposited on a substrate used to cover displays to block RF radiation while permitting optical viewing.

TEM Cells - Transverse electromagnetic cell; a chamber that maintains its characteristic impedance throughout its volume. Cable, connector assemblies, and electronic devices are placed inside the cell. The cell also can be used as a detector to measure radiation emitted by devices inside the cell.

Voltage Standing Wave Ratio - A measure of the degree to which a load is impedance matched to its transmission line. A perfect match has a VSWR of 1.0 while an imperfect match has a greater standing wave ratio value.

Waveguide - A dielectric or metallic medium that confines, supports, and guides the energy of propagating wave, such as an electromagnetic or acoustic wave, along a prescribed and controllable path.

RESTRICTION OF HAZARDOUS SUBSTANCES

(RoHS)

East Coast Shielding is committed to protecting the environment and complying with the European Directive regarding the Restriction of Hazardous Substances (RoHS). Parts are considered compliant to the RoHS Directive if incidental concentrations of the following substances are below the adopted limits.

SUBSTANCE	ALLOWABLE MAXIMUM CONCENTRATION
Lead (Pb)	0.1% by weight
Mercury (Hg)	0.1% by weight
Cadmium (Cd)	0.01% by weight
Hexavalent Chromium (CrVI)	0.1% by weight
Polybrominated Biphenyls (PBB)	0.1% by weight
Polybrominated Diphenyl ethers (PBDE)	0.1% by weight

RoHS status can be pre-determined through the absence or use of the above mentioned substances. For example, a Tin/Lead or Cadmium plated part would not be certified RoHS compliant.



EAST COAST SHIELDING

Custom Gasket Material

When it comes to custom gasket fabrication, East Coast Shielding offers you a full service package and can help you with everything from design issues to implementation. We can suggest different materials from our complete range of products. We can also match the requirements of your custom gasket with the compound and the process that gives you the best performance & value. Then we design and fabricate your gaskets.

East Coast Shielding specializes in crafting large and molded custom gaskets. We can fabricate single pieces as bonded construction gaskets to fit your needs.

FABRICATING THE GASKET

At East Coast Shielding, we eliminate leaks and guarantee superior performance by utilizing four corner bonded construction for all of our custom over-sized gaskets—the extra protection ensures that the gasket prevents leakage and preserves shielded components from the ravages of moisture & exposure.

Don't Trust your over-sized, customer gasket needs to just anyone...go with East Coast Shielding. We are industry leaders and have been exceeding the expectations of clients around the world for almost a decade.

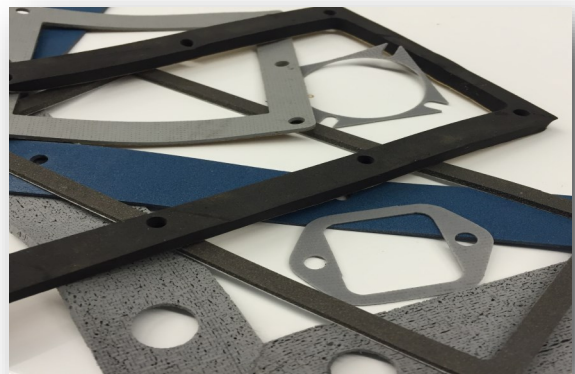
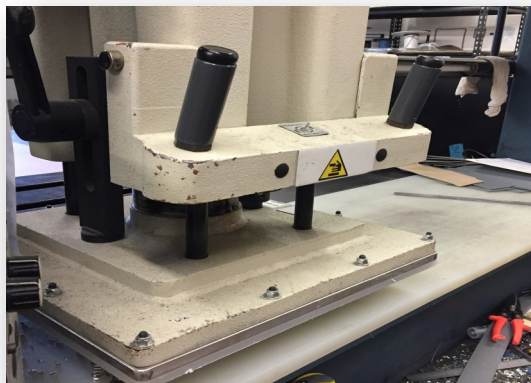

SELECTING MATERIALS

If you know what kind of material you need, perfect: we'll take care of the rest. However, many of our clients come to us with an idea or two about what they are looking for, but unaware of the range of materials and compounds that can get the job done. Our customer gasket design advisors can help review the products available, provide you with an overview of the strengths and advantages of each. We can then help you select the material that offers the best performance and the greatest value.

EAST COAST SHIELDING

Custom Gasket Material

DIE CUTTING

How does East Coast Shielding do die cutting? The way it's supposed to be done: with state of the art die cutting equipment, run by experienced craftsmen who have been getting the job done right for almost a decade. There's nothing we haven't seen, no challenge that can't be solved once our technicians & engineers get a look at it. We take pride in delivering top quality work to our customers.

Crafting a precision die is meticulous work, one that demands skill & accuracy. You want a cut that performs well (for quality) and does it without excess waste (to minimize material costs). Die design is an important part of our job and one that we take seriously. No slapped together designs that result in a poor quality, inefficient cut. No wasted time, money or effort. Our design team uses the latest computer technology to match your needs with their ideas and export a design that will stand the test of time.

CUSTOM DIE CUTTING SERVICES

- Design Assistance— we can lend an outstretched hand of support with part configuration, material and adhesive selection and other technical aspects vital to the performance of your product.
 - Prototype— we can produce prototype parts for actual functional testing quickly & efficiently.
- Short or Long Run Production— per your requirements, we can produce both short and long runs in an expert fashion.
- Quality Control— through the series of steps from initial raw inspection to the end result of the finished product, our quality control is unsurpassed insuring compliance to specifications.

MATERIALS FOR DIE CUT GASKETS & SEALS

- Conductive Silicone (ECS3 Series)
- Wire Oriented in Silicone (ECS4 Series)
- Nonconductive solid silicone and silicone sponge (ECS300 Series)
 - Neoprene solid and sponge
 - Nitrile Rubber
 - And more

EAST COAST SHIELDING

ECS CONNECTOR GASKETS : Non Military type (pages 9, 10)

Military type per M83528/002-M83528/005 (pages 11, 12, 13)

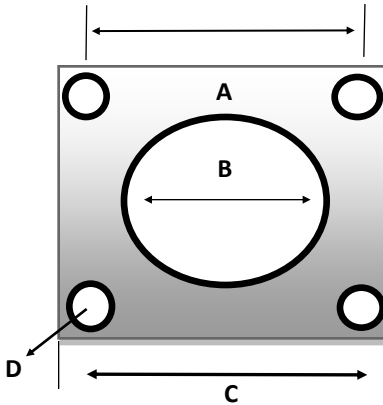

ECS Connector Gaskets can be die-cut from all ECS listed materials. The material listed below details ECS4 .032 thk oriented wire in solid silicone and .020 thk synthetic or silicone filled woven aluminum (24 x 24 aluminum screen). Also available in ECS3 Series conductive elastomers. Also available; M83528/004 connectors (see below)



STANDARD GASKETS / MIL-C-5015, MS-3102 CONNECTORS DIMENSIONS IN INCHES

Shell Size	Dimensions				Woven Aluminum 24 x 24 Mesh		ECS4 Series
	A	B	C	D	Neoprene	Silicone	
8	.594	.500	.875	.172	ECS6-200	ECS6-201	ECS4-202
10	.719	.625	1.000	.172	ECS6-203	ECS6-204	ECS4-205
12	.813	.750	1.094	.172	ECS6-206	ECS6-207	ECS4-208
14	.906	.875	1.188	.172	ECS6-209	ECS6-210	ECS4-211
16	.969	1.000	1.281	.172	ECS6-212	ECS6-213	ECS4-214
18	1.063	1.125	1.375	.203	ECS6-215	ECS6-216	ECS4-217
20	1.156	1.250	1.500	.203	ECS6-218	ECS6-219	ECS4-220
22	1.250	1.375	1.625	.203	ECS6-221	ECS6-222	ECS4-223
24	1.375	1.500	1.750	.203	ECS6-224	ECS6-225	ECS4-226
28	1.563	1.750	2.000	.203	ECS6-227	ECS6-228	ECS4-229
32	1.750	2.000	2.250	.219	ECS6-230	ECS6-231	ECS4-232
36	1.938	2.188	2.500	.219	ECS6-233	ECS6-234	ECS4-235
40	2.188	2.438	2.750	.219	ECS6-236	ECS6-237	ECS4-238
44	2.375	2.781	3.000	.219	ECS6-239	ECS6-240	ECS4-241
48	2.625	3.031	3.250	.219	ECS6-242	ECS6-243	ECS4-244

EAST COAST SHIELDING

ECS CONNECTOR GASKETS

For PT&PC, JT, MS-3110, MS-3112, MS-3119, MS-3120, MIL-C-26482 Connectors, Dimensions in inches

Shell Size	Dimensions				Woven Aluminum 24 x 24 Mesh		ECS4 Series
	A	B	C	D	Neoprene	Silicone	
6	.469	.375	.688	.130	ECS6-245	ECS6-246	ECS4-247
8	.594	.500	.812	.130	ECS6-248	ECS6-249	ECS4-250
10	.719	.625	.938	.130	ECS6-251	ECS6-252	ECS4-253
12	.813	.750	1.031	.130	ECS6-254	ECS6-255	ECS4-256
14	.906	.875	1.125	.130	ECS6-257	ECS6-258	ECS4-259
16	.969	1.000	1.219	.130	ECS6-260	ECS6-261	ECS4-262
18	1.063	1.125	1.312	.130	ECS6-263	ECS6-264	ECS4-265
20	1.156	1.250	1.438	.130	ECS6-266	ECS6-267	ECS4-268
22	1.250	1.375	1.563	.130	ECS6-269	ECS6-270	ECS4-271
24	1.375	1.500	1.688	.156	ECS6-272	ECS6-273	ECS4-274
Shell Size	Dimensions				Woven Aluminum 24 x 24 Mesh		ECS4 Series
	A	B	C	D	Neoprene	Silicone	
6	.641	.375	.953	.160	ECS6-275	ECS6-276	ECS4-277
8	.734	.500	1.047	.160	ECS6-278	ECS6-279	ECS4-280
10	.812	.625	1.125	.160	ECS6-281	ECS6-282	ECS4-283
12	.938	.750	1.250	.160	ECS6-284	ECS6-285	ECS4-286
14	1.031	.875	1.344	.160	ECS6-287	ECS6-288	ECS4-289
16	1.125	1.000	1.437	.160	ECS6-290	ECS6-291	ECS4-292
18	1.203	1.125	1.516	.160	ECS6-293	ECS6-294	ECS4-295
20	1.297	1.250	1.672	.160	ECS6-296	ECS6-297	ECS4-298
22	1.375	1.375	1.750	.160	ECS6-299	ECS6-300	ECS4-301

EAST COAST SHIELDING

ECS CONNECTOR GASKETS : M83528/004

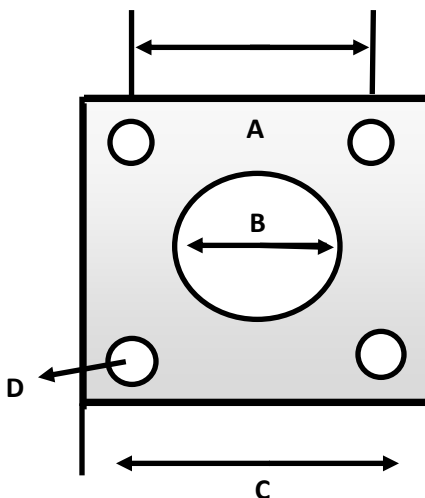

Available in

ECS 1000 / 2000 5000 5000 F 6000 8000 8000F

Type: B Type D Type M Type A & K Type C

P/N example ECS3 - XXX - XXXX Specification in table below

ECS Series	ECS Pt #	Material
Example: M83528	004	B (material)

The following are the most commonly required Connector Gaskets for Military & Commercial market. The standard thickness is .032+- .005

Part #	"A"	"B"	"C"	"D"	M83528/004
ECS3-301-XXX	.469	.375	.738	.141	004/001
ECS3-302-XXX	.594	.630	.840	.135	004/002
ECS3-303-XXX	.594	.568	.812	.125	004/003
ECS3-304-XXX	.594	.500	.812	.156	004/004
ECS3-305-XXX	.719	.750	.965	.135	004/005
ECS3-306-XXX	.719	.680	.937	.125	004/006
ECS3-307-XXX	.719	.625	1.000	.156	004/007
ECS3-308-XXX	.812	.875	1.060	.141	004/008
ECS3-309-XXX	.813	.750	1.094	.141	004/009

EAST COAST SHIELDING

ECS CONNECTOR GASKETS : Military type per M83528/004

Part #	“A”	“B”	“C”	“D”	M83528/004
ECS3-310-XXXX	.906	1.005	1.153	.135	004/010
ECS3-311-XXXX	.906	.938	1.125	.125	004/011
ECS3-312-XXXX	.906	.875	1.188	.156	004/012
ECS3-313-XXXX	.969	1.135	1.258	.156	004/013
ECS3-314-XXXX	.969	1.063	1.250	.125	004/014
ECS3-315-XXXX	.969	1.000	1.281	.156	004/015
ECS3-316-XXXX	1.062	1.260	1.351	.156	004/016
ECS3-317-XXXX	1.062	1.189	1.343	.125	004/017
ECS3-318-XXXX	1.062	1.135	1.375	.156	004/018
ECS3-319-XXXX	1.156	1.375	1.500	.141	004/019
ECS3-320-XXXX	1.156	1.312	1.467	.125	004/020
ECS3-321-XXXX	1.156	1.250	1.500	.172	004/021
ECS3-322-XXXX	1.250	1.500	1.625	.141	004/022
ECS3-323-XXXX	1.250	1.437	1.562	.125	004/023
ECS3-324-XXXX	1.250	1.375	1.625	.172	004/024
ECS3-325-XXXX	1.375	1.625	1.750	.172	004/025
ECS3-326-XXXX	1.375	1.563	1.703	.152	004/026
ECS3-327-XXXX	1.375	1.500	1.750	.203	004/027
ECS3-328-XXXX	1.500	1.750	1.875	.172	004/028
ECS3-329-XXXX	1.563	1.750	2.000	.203	004/029
ECS3-330-XXXX	1.750	2.000	2.250	.219	004/030
ECS3-331-XXXX	1.938	2.250	2.500	.219	004/031
ECS3-332-XXXX	2.188	2.500	2.750	.219	004/032
ECS3-333-XXXX	2.375	2.781	3.000	.219	004/033
ECS3-334-XXXX	2.625	3.031	3.250	.219	004/034

EAST COAST SHIELDING

ECS CONNECTOR GASKETS : Military type per M83528/004

ECS CONNECTOR GASKETS : M83528/004

* Material Table Below *

	Carbon 1000	Nickel Graphite 2000	Nickel Graphite 2000F	Silver Aluminum* 5000	Silver Aluminum* 5000F	Silver Glass 6000	Silver Copper* 8000
Elastomer	Silicone	Silicone	Fluoro-silicone	Silicone	Fluoro-silicone	Silicone	Silicone
Color	Black	Dark Gray	Dark Gray	Blue	Blue	Tan	Tan
Specific Gravity, gm/cc	1.2	1.95	1.95	2.0	2.0	1.9	3.5
Durometer Shore A	70	30-70	65	65	70	65	65
Volume Resistivity, Ohm-cm	7.0	0.10	0.10	0.008	0.012	0.006	0.004
Operating Temperature: Min C	-55°	-55°	-55°	-55°	-55°	-55°	-55°
Operating Temperature: Max C	200°	150°	150°	160°	160°	160°	125°
Compression Deflection % Min.	3.5	3.5	3.0	3.5	3.5	3.5	3.5
Tensile Strength, P.S.I.	650	150	150	200	180	200	200
Elongation % Min.	100%	100%	100%	100%	60%	100%	100%
Elongation % Max.	-	-	-	300%	260%	300%	300%
Compression Set %	40	35	25	32	30	30	32
Tear Strength lb./in.	40	40	35	30	35	30	25
Shielding Effectiveness (100 Mhz)	80	100	100	120	120	100	120
Shielding Effectiveness (500 Mhz)	80	100	100	120	120	100	120
Shielding Effectiveness (2 Ghz)	60	100	100	115	115	90	120
Shielding Effectiveness (10 Ghz)	50	100	100	115	115	90	120

* See next page for actual data (MIL-DTL-83528H Qualifying results for types A, B, D, & K) *

EAST COAST SHIELDING
Qualifying Data for Types A, B, D, & K

	Silver Aluminum 5000-65 (Type B)	Silver Aluminum 5000F-70 (Type D)	Silver Copper 8000-65 (Type A)	Silver Copper 8000-85 (Type K)
Elastomer	Silicone	Fluorosilicone	Silicone	Silicone
Color	Blue	Blue	Tan	Tan
Specific Gravity, g/cc	2.0689	2.1998	3.5976	3.6612
Durometer, Shore A	67.66	70	71.33	81.33
Volume Resistivity, ohm-cm	.00278	.00326	.00107	.00127
Compression Deflection, %	16.66	13.217	12.793	12.793
Tensile Strength, PSI	278.108	330.137	353.004	602.853
Elongation, %	222.282	190.895	254.002	265.042
Compression Set, %	12.74	21.08	25.1533	25.6933
Tear Strength, lb./in.	53.192	66.972	54.837	81.169
Electrical Stability After Break, ohm-cm	.00295	.0072	.00097	.00186
Vibration, Ohm-cm During/After	.00719/.00126	.00213/.00089	.00279/.000413	.00145/.00045
Low Temp. Flex, °C TR10/TR70	-70 °C/-65 °C	-67.6 °C/-61.33 °C	-69 °C/-69 °C	-69.8 °C/-69.8 °C
Life Testing, Ohm-cm	.0046	.00632	.00548	.00616
EMP, Ohm-cm	.0083	.0103	.0053	.005
Fluid Immersion, Survivability	Not Survivable	Survivable	Not Survivable	Not Survivable
Shielding Effectiveness, 100 MHz	125	119	125	127
Shielding Effectiveness, 500 MHz	120	121	131	134
Shielding Effectiveness, 2 GHz	123	123	120	132
Shielding Effectiveness, 10 GHz	122	121	126	128

EAST COAST SHIELDING

Bonded O-Rings : Non Military type (pages 14 & 15)

Military type per M83528/002 - M83528/005 (pages 16,17,18, 19 & 20)

East Coast Shielding is one of the nation's premier fabricators of O-rings. We offer O-rings in a wide range of material types. Including extruded & vulcanized types of rubber, conductive materials and more. We have O-ring stock available in standard inch sizes, as well as metric. We can also create custom O-rings to meet your specifications. Need an O-ring designed? We can do that too! We are proud to supply O-rings across the country, and around the world, to companies in over a dozen different industries.

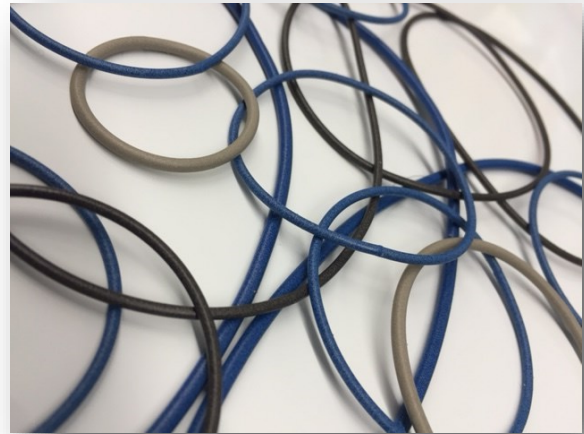
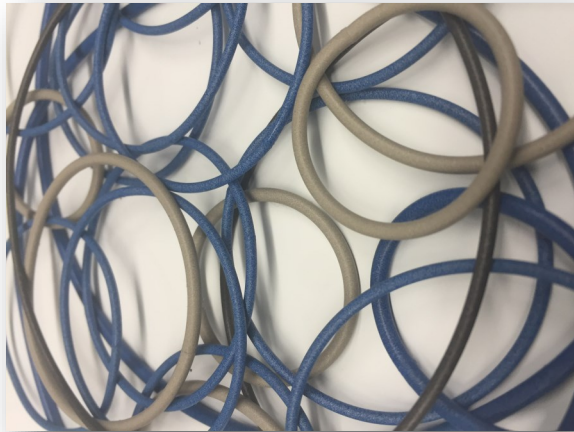

SPLICED and VULCANIZED O-RINGS

ECS3 Series & ECS300 Series Capabilities

East Coast Shielding provides spliced or vulcanized O-rings made from conductive & non-conductive silicone that can be used in environmental sealing and other semiconductor processing applications. Extruded cord stock is available in many standard cross-sections. Spliced or vulcanized O-rings are made from an extruded cord and then vulcanized to form the O-ring size (ID) required. Spliced O-rings are a low cost, effective solution when standard O-rings cannot be used. East Coast Shielding provides spliced O-rings with ID's that range from 1" up. Splices at the joints are almost seamless.

Splicing method created by East Coast Shielding enables a quick production of O-rings that conform to most industry specifications or to your custom requirements. This technology reduces the manufacturing time for spliced O-rings as well as the cost hurdles associated with custom O-rings. Whether your intended use is prototyping or large-scale commercialization, spliced O-rings deliver a quick-sealing solution.

The available standard cross sections are: 0.040", 0.062", 0.070", 0.103", 0.139", 0.210", 0.275", 0.312", 0.375", 0.500"

If some of your applications may require tighter Cross-Section Tolerances, East Coast Shielding can provide whatever your requirements may be.

EAST COAST SHIELDING

Bonded O-Rings

Advantages of Spliced O-Rings:

- O-rings or Seals can be made from a range of compounds (ECS3 Series Conductive Silicone & ECS300 Series Non-Conductive Silicone)
- No Tooling required for standard ID/OD O-Rings Cord
- O-rings can be made in virtually any diameter and length
- Shorter lead times and faster delivery than molded rings

O-Ring Cord Cut Length Calculator:

Calculated O-ring Cord Cut Length: $((OD+ID)/2) \times \text{Pi} = \text{length}$

(Pi = 3.1416), ID = OD - (2 x C/S)

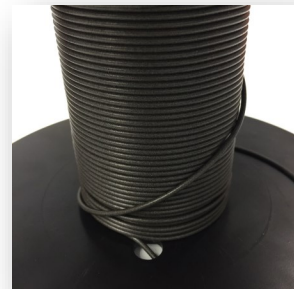
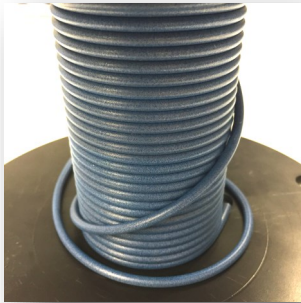

O-Ring Materials

An O-ring is only as good as the material it is crafted from. East Coast Shielding makes certain that we have a huge selection of top quality materials to choose from:

- Silicone (ECS300 Series)
 - Fluorosilicone
- Conductive elastomers (ECS3 Series & M83528/001) .040" - .250" Cross Section
 - Silicone sponge elastomers (ECS300 Series)

Our massive selection of materials guarantees that we can make an O-ring that is right for you no matter what the application. Please ask us about custom material.

EAST COAST SHIELDING

Bonded O-Rings : Military type per M83528/002—M83528/005

Available in

ECS 1000 / 2000 5000 5000 F 6000 8000 8000F

Type: B Type D Type M Type A & K Type C

P/N example ECS3 - XXXX - XXXX Specification in table below

ECS Series	ECS Pt #	Material	
M83528	002/005 (size)	B (material)	001 (size)

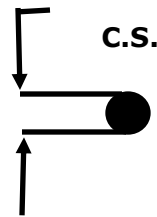
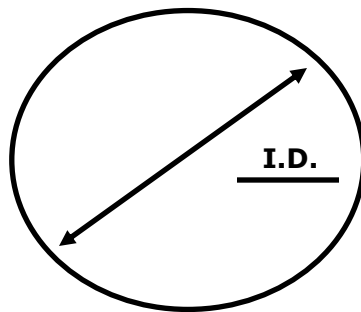

Part #	C.S.	I.D.	M83528/002	M83528/005
ECS3-200-XXXX	.030	.442		005/001
ECS3-201-XXXX	.030	.577		005/002
ECS3-202-XXXX	.030	.692		005/003
ECS3-203-XXXX	.030	.817		005/004
ECS3-204-XXXX	.039	.425		005/005
ECS3-205-XXXX	.048	.295		005/006
ECS3-206-XXXX	.050	.533		005/007

EAST COAST SHIELDING

Bonded O-Rings : M83528/002 - M83528/005

Part #	C.S.	I.D.	M83528/002	M83528/005
ECS3-207-XXXX	.051	.446	-	005/008
ECS3-208-XXXX	.057	.415	-	005/009
ECS3-209-XXXX	.063	.541	-	005/010
ECS3-210-XXXX	.063	.648	-	005/011
ECS3-211-XXXX	.068	.847	-	005/012
ECS3-212-XXXX	.068	1.182	-	005/013
ECS3-213-XXXX	.068	6.165	-	005/014
ECS3-214-XXXX	.070	.145	002/007	-
ECS3-215-XXXX	.070	.301	002/011	-
ECS3-216-XXXX	.070	.364	002/012	-
ECS3-217-XXXX	.070	.426	002/013	-
ECS3-218-XXXX	.070	.489	002/014	-
ECS3-219-XXXX	.070	.495	-	005/015
ECS3-220-XXXX	.070	.551	002/015	-
ECS3-221-XXXX	.070	.610	-	005/016
ECS3-222-XXXX	.070	.635	-	005/017
ECS3-223-XXXX	.070	.667	-	005/018
ECS3-224-XXXX	.070	.676	002/017	-
ECS3-225-XXXX	.070	.739	002/018	-
ECS3-226-XXXX	.070	.801	002/019	-
ECS3-227-XXXX	.070	.860	-	005/019
ECS3-228-XXXX	.070	.864	002/020	-
ECS3-229-XXXX	.070	.926	002/021	-
ECS3-230-XXXX	.070	.989	002/022	-
ECS3-231-XXXX	.070	1.114	002/024	-
ECS3-232-XXXX	.070	1.176	002/025	-
ECS3-233-XXXX	.070	1.230	-	005/020
ECS3-234-XXXX	.070	1.239	002/026	-
ECS3-235-XXXX	.070	1.364	002/028	-
ECS3-236-XXXX	.070	1.614	002/030	-
ECS3-237-XXXX	.070	1.864	002/032	-
ECS3-238-XXXX	.070	3.489	002/043	-
ECS3-239-XXXX	.103	.612	002/114	-
ECS3-240-XXXX	.103	.676	002/115	-

EAST COAST SHIELDING

Bonded O-Rings : M83528/002 - M83528/005 - M83528/013

Part #	C.S.	I.D.	M83528/002	M83528/005	M83528/013
ECS3-241-XXXX	.103	.799	002 / 017	-	-
ECS3-242-XXXX	.103	1.362	002 / 126	-	-
ECS3-243-XXXX	.103	1.487	002 / 128	-	-
ECS3-244-XXXX	.103	1.612	-	005 / 022	-
ECS3-245-XXXX	.103	1.737	002 / 132	-	-
ECS3-246-XXXX	.103	1.790	-	005 / 023	-
ECS3-247-XXXX	.103	1.862	002 / 134	-	-
ECS3-248-XXXX	.103	2.362	002 / 142	-	-
ECS3-249-XXXX	.103	2.550	002 / 145	-	-
ECS3-250-XXXX	.103	3.987	002 / 155	-	-
ECS3-251-XXXX	.115	2.683	-	-	013 / 029
ECS3-252-XXXX	.139	2.011	-	-	013 / 022

EAST COAST SHIELDING

Bonded O-Rings : M83528/002 - M83528/005

* Material table below *

	Carbon 1000	Nickel Graphite 2000	Nickel Graphite 2000F	Silver Aluminum 5000*	Silver Aluminum 5000F*	Silver Glass 6000	Silver Copper 8000*
Elastomer	Silicone	Silicone	Fluoro- silicone	Silicone	Fluoro- silicone	Silicone	Silicone
Color	Black	Dark Gray	Dark Gray	Blue*	Blue*	Tan	Tan
Specific Gravity, gm/cc	1.2	1.95	1.95	2.0	2.0	1.9	3.5
Durometer Shore A	70	30-70	65	65	70	65	65
Volume Resistivity, Ohm-cm	7.0	0.10	0.10	0.008	0.012	0.006	0.004
Operating Temperature: Min C	-55°	-55°	-55°	-55°	-55°	-55°	-55°
Operating Temperature: Max C	200°	150°	150°	160°	160°	160°	125°
Compression Deflection % Min.	3.5	3.5	3.0	3.5	3.5	3.5	3.5
Tensile Strength, P.S.I.	650	150	150	200	180	200	200
Elongation % Min.	100%	100%	100%	100%	60%	100%	100%
Elongation % Max.	-	-	-	300%	260%	300%	300%
Compression Set %	40	35	25	32	30	30	32
Tear Strength lb./in.	40	40	35	30	35	30	25
Shielding Effectiveness (100 Mhz)	80	100	100	120	120	100	120
Shielding Effectiveness (500 Mhz)	80	100	100	120	120	100	120
Shielding Effectiveness (2 Ghz)	60	100	100	115	115	90	120
Shielding Effectiveness (10 Ghz)	50	100	100	115	115	90	120

* See next page for actual data (MIL-DTL-83528H Qualifying results for types A, B, D, & K) *

EAST COAST SHIELDING
Qualifying Data for Types A, B, D, & K

	Silver Aluminum 5000-65 (Type B)	Silver Aluminum 5000F-70 (Type D)	Silver Copper 8000-65 (Type A)	Silver Copper 8000-85 (Type K)
Elastomer	Silicone	Fluorosilicone	Silicone	Silicone
Color	Blue	Blue	Tan	Tan
Specific Gravity, g/cc	2.0689	2.1998	3.5976	3.6612
Durometer, Shore A	67.66	70	71.33	81.33
Volume Resistivity, ohm-cm	.00278	.00326	.00107	.00127
Compression Deflection, %	16.66	13.217	12.793	12.793
Tensile Strength, PSI	278.108	330.137	353.004	602.853
Elongation, %	222.282	190.895	254.002	265.042
Compression Set, %	12.74	21.08	25.1533	25.6933
Tear Strength, lb./in.	53.192	66.972	54.837	81.169
Electrical Stability After Break, ohm-cm	.00295	.0072	.00097	.00186
Vibration, Ohm-cm During/After	.00719/.00126	.00213/.00089	.00279/.000413	.00145/.00045
Low Temp. Flex, °C TR10/TR70	-70 °C/-65 °C	-67.6 °C/-61.33 °C	-69 °C/-69 °C	-69.8 °C/-69.8 °C
Life Testing, Ohm-cm	.0046	.00632	.00548	.00616
EMP, Ohm-cm	.0083	.0103	.0053	.005
Fluid Immersion, Survivability	Not Survivable	Survivable	Not Survivable	Not Survivable
Shielding Effectiveness, 100 MHz	125	119	125	127
Shielding Effectiveness, 500 MHz	120	121	131	134
Shielding Effectiveness, 2 GHz	123	123	120	132
Shielding Effectiveness, 10 GHz	122	121	126	128

Conduct-O-Knit Knitted Wire Mesh

ECS1 Series

ECS1 Series Conduct-O-Knit materials consist of an elastomer core with knitted wire mesh or as a knitted wire mesh over. The knitted wire mesh can be fabricated with .0035" (0.089) or .0045" (.114) diameter Monel or SnCuFe (tin-plated, copper-clad steel) Wire or with .005" (.127) diameter Aluminum Wire. The standard wire materials are Monel. Monel is used mostly because of its good aging properties & excellent tensile strength. The elastomer cores are available in Neoprene Sponge, Silicone Sponge, or Solid Silicone Tubing.

APPLICATIONS

East Coast Shielding Conduct-O-Knit provides first rate shielding in applications that need more robust gaskets. The wire mesh is perfect for applications that don't require an environmental seal. We suggest Conduct-O-Knit knitted wire mesh over an elastomer core for applications that need a sealing against the environment.

OPTIONS

We offer continuous length spools or can customize and cut to length based on your needs of your business. East Coast Shielding Conduct-O-Knit can be manufactured into an unlimited number of configurations.



Material Specifications

Monel Wire—.0035"/.0045 Diameter

SnCuFe Wire

Aluminum Wire—.005" Diameter

Tin-Plated Phosphor

Bronze Wire—.0045" Diameter

Neoprene Sponge Elastomer

Silicone Sponge Elastomer

Silicone Solid Elastomer

QQ-N-281

ASTM-B-520, 2-3% tin plating, 30-40% copper cladding and balance of weight is steel

Alloy 5056, MAS-4182

Phosphor Bronze Per ASTM B-105

Tin-Plate Per ASTM B-33

MIL-R-6130B Type II Grade A, Condition medium

AMS-3195

ZZ-R-765 Class 2B, Grade 40

Conduct-O-Knit Available Configurations

ECS1 Series

RECTANGULAR MESH

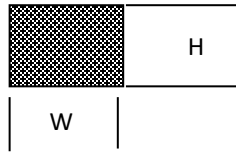

ROUND MESH WITH FIN

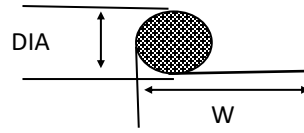

WIDTH (W)	HEIGHT (H)	ECS PART NUMBER	
		MONEL	SnCuFe
0.062 (1.57)	0.062 (1.57)	ECS1-1	ECS1-2
0.062 (1.57)	0.125 (3.18)	ECS1-3	ECS1-4
0.062 (1.57)	0.188 (4.78)	ECS1-4	ECS1-6
0.062 (1.57)	0.250 (6.35)	ECS1-7	ECS1-8
0.062 (1.57)	0.312 (7.92)	ECS1-9	ECS1-10
0.062 (1.57)	0.375 (9.53)	ECS1-11	ECS1-12
0.062 (1.57)	0.500 (12.70)	ECS1-13	ECS1-14
0.062 (1.57)	0.625 (15.88)	ECS1-15	ECS1-16
0.062 (1.57)	0.750 (19.05)	ECS1-17	ECS1-18
0.062 (1.57)	1.000 (25.40)	ECS1-19	ECS1-20
0.093 (2.36)	0.093 (2.36)	ECS1-21	ECS1-22
0.093 (2.36)	0.125 (3.18)	ECS1-23	ECS1-24
0.093 (2.36)	0.188 (4.78)	ECS1-25	ECS1-26
0.093 (2.36)	0.250 (6.35)	ECS1-27	ECS1-28
0.093 (2.36)	0.312 (7.92)	ECS1-29	ECS1-30
0.093 (2.36)	0.375 (9.53)	ECS1-31	ECS1-32
0.093 (2.36)	0.500 (12.70)	ECS1-33	ECS1-34
0.093 (2.36)	0.625 (15.88)	ECS1-35	ECS1-36
0.125 (3.18)	0.125 (3.18)	ECS1-37	ECS1-38
0.125 (3.18)	0.156 (3.96)	ECS1-39	ECS1-40
0.125 (3.18)	0.188 (4.78)	ECS1-41	ECS1-42
0.125 (3.18)	0.250 (6.35)	ECS1-43	ECS1-44
0.125 (3.18)	0.312 (7.92)	ECS1-45	ECS1-46
0.125 (3.18)	0.375 (9.53)	ECS1-47	ECS1-48
0.125 (3.18)	0.500 (12.70)	ECS1-49	ECS1-50
0.125 (3.18)	0.625 (15.88)	ECS1-51	ECS1-52
0.125 (3.18)	0.750 (19.05)	ECS1-53	ECS1-54
0.125 (3.18)	1.000 (25.40)	ECS1-55	ECS1-56
0.188 (4.78)	0.188 (4.78)	ECS1-57	ECS1-58
0.188 (4.78)	0.250 (6.35)	ECS1-59	ECS1-60
0.188 (4.78)	0.312 (7.92)	ECS1-61	ECS1-62
0.188 (4.78)	0.375 (9.53)	ECS1-63	ECS1-64
0.188 (4.78)	0.500 (12.70)	ECS1-65	ECS1-66
0.188 (4.78)	0.625 (15.88)	ECS1-67	ECS1-68
0.188 (4.78)	0.750 (19.05)	ECS1-69	ECS1-70
0.188 (4.78)	1.000 (25.40)	ECS1-71	ECS1-72
0.250 (6.35)	0.250 (6.35)	ECS1-73	ECS1-74
0.250 (6.35)	0.312 (7.92)	ECS1-75	ECS1-76
0.250 (6.35)	0.375 (9.53)	ECS1-77	ECS1-78
0.250 (6.35)	0.500 (12.70)	ECS1-79	ECS1-80
0.250 (6.35)	0.625 (15.88)	ECS1-81	ECS1-82
0.250 (6.35)	0.750 (19.05)	ECS1-83	ECS1-84
0.250 (6.35)	1.000 (25.40)	ECS1-85	ECS1-86
0.312 (7.92)	0.312 (7.92)	ECS1-87	ECS1-88
0.375 (9.53)	0.375 (9.53)	ECS1-89	ECS1-90
0.375 (9.53)	0.625 (15.88)	ECS1-91	ECS1-92

DIA (D)	OVERALL WIDTH (W)	ECS PART NUMBER	
		MONEL	SnCuFe
0.062 (1.57)	0.375 (9.53)	ECS1-93	ECS1-94
0.062 (1.57)	0.500 (12.70)	ECS1-95	ECS1-96
0.062 (1.57)	0.625 (15.88)	ECS1-97	ECS1-98
0.062 (1.57)	0.750 (19.05)	ECS1-99	ECS1-100
0.093 (2.36)	0.375 (9.53)	ECS1-101	ECS1-102
0.093 (2.36)	0.500 (12.70)	ECS1-103	ECS1-104
0.093 (2.36)	0.750 (19.05)	ECS1-105	ECS1-106
0.125 (3.18)	0.375 (9.53)	ECS1-107	ECS1-108
0.125 (3.18)	0.437 (11.11)	ECS1-109	ECS1-110
0.125 (3.18)	0.500 (12.70)	ECS1-111	ECS1-112
0.125 (3.18)	0.562 (14.27)	ECS1-113	ECS1-114
0.125 (3.18)	0.625 (15.88)	ECS1-115	ECS1-116
0.125 (3.18)	0.750 (19.05)	ECS1-117	ECS1-118
0.156 (3.96)	0.500 (12.70)	ECS1-119	ECS1-120
0.156 (3.96)	0.750 (19.05)	ECS1-121	ECS1-122
0.188 (4.78)	0.437 (11.11)	ECS1-123	ECS1-124
0.188 (4.78)	0.500 (12.70)	ECS1-125	ECS1-126
0.188 (4.78)	0.625 (15.88)	ECS1-127	ECS1-128
0.188 (4.78)	0.750 (19.05)	ECS1-129	ECS1-130
0.188 (4.78)	0.875 (22.23)	ECS1-131	ECS1-132
0.250 (6.35)	0.500 (12.70)	ECS1-133	ECS1-134
0.250 (6.35)	0.625 (15.88)	ECS1-135	ECS1-136
0.250 (6.35)	0.750 (19.05)	ECS1-137	ECS1-138
0.250 (6.35)	0.875 (22.23)	ECS1-139	ECS1-140
0.250 (6.35)	1.000 (25.40)	ECS1-141	ECS1-142
0.312 (7.92)	0.625 (15.88)	ECS1-143	ECS1-144
0.312 (7.92)	0.750 (19.05)	ECS1-145	ECS1-146
0.312 (7.92)	0.875 (22.23)	ECS1-147	ECS1-148
0.375 (9.53)	0.625 (15.88)	ECS1-149	ECS1-150
0.375 (9.53)	0.750 (19.05)	ECS1-151	ECS1-152
0.375 (9.53)	0.875 (22.23)	ECS1-153	ECS1-154
0.375 (9.53)	1.000 (25.40)	ECS1-155	ECS1-156
0.437 (11.11)	0.750 (19.05)	ECS1-157	ECS1-158
0.437 (11.11)	0.875 (22.23)	ECS1-159	ECS1-160
0.437 (11.11)	1.000 (25.40)	ECS1-161	ECS1-162
0.500 (12.70)	0.750 (19.05)	ECS1-163	ECS1-164
0.500 (12.70)	0.875 (22.23)	ECS1-165	ECS1-166
0.500 (12.70)	1.000 (25.40)	ECS1-167	ECS1-168

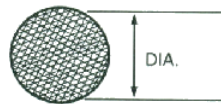

ROUND MESH

DIA (D)	ECS PART NUMBER	
	MONEL	SnCuFe
0.062 (1.57)	ECS1-169	ECS1-170
0.093 (2.36)	ECS1-171	ECS1-172
0.125 (3.18)	ECS1-173	ECS1-174
0.156 (3.96)	ECS1-175	ECS1-176
0.188 (4.78)	ECS1-177	ECS1-178
0.250 (6.35)	ECS1-179	ECS1-180
0.312 (7.92)	ECS1-181	ECS1-182
0.375 (9.53)	ECS1-183	ECS1-184
0.437 (11.11)	ECS1-185	ECS1-186
0.500 (12.70)	ECS1-187	ECS1-188

Conduct-O-Knit Round Tubing Core ECS1 Series

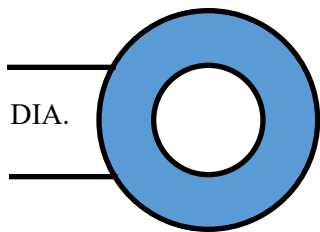

CORE DIA.*	ECS PART NUMBER	
	SILICONE SOLID TUBE	
	MONEL	SnCuFe
0.188 (4.78)	ECS1-189	ECS1-190
0.250 (6.35)	ECS1-191	ECS1-192
0.375 (9.53)	ECS1-193	ECS1-194
0.500 (12.70)	ECS1-195	ECS1-196

* These dimensions are for the elastomer core. Add 0.032" (0.81)
for outside dimensions or diameters.

Conduct-O-Knit Available Configurations

ECS1 Series

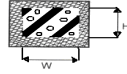

RECTANGULAR WITH SPONGE CORE

CORE HEIGHT(H)	CORE WIDTH (W)	PART NUMBER			
		NEOPRENE SPONGE		SILICONE SPONGE	
		MONEL	SnCuFe	MONEL	SnCuFe
0.125 (3.18)	0.125 (3.18)	ECS1-197	ECS1-198	ECS1-199	ECS1-200
0.125 (3.18)	0.156 (3.96)	ECS1-201	ECS1-202	ECS1-203	ECS1-204
0.125 (3.18)	0.188 (4.78)	ECS1-205	ECS1-206	ECS1-207	ECS1-208
0.125 (3.18)	0.250 (6.35)	ECS1-209	ECS1-210	ECS1-211	ECS1-212
0.188 (4.78)	0.188 (4.78)	ECS1-213	ECS1-214	ECS1-215	ECS1-216
0.250 (6.35)	0.250 (6.35)	ECS1-217	ECS1-218	ECS1-219	ECS1-220
0.250 (6.35)	0.375 (9.53)	ECS1-221	ECS1-222	ECS1-223	ECS1-224
0.250 (6.35)	0.500 (12.70)	ECS1-225	ECS1-226	ECS1-227	ECS1-228
0.375 (9.53)	0.500 (12.70)	ECS1-229	ECS1-230	ECS1-231	ECS1-232
0.375 (9.53)	0.625 (15.88)	ECS1-233	ECS1-234	ECS1-235	ECS1-236
0.500 (12.70)	0.500 (12.70)	ECS1-237	ECS1-238	ECS1-239	ECS1-240
0.500 (12.70)	0.750 (19.05)	ECS1-241	ECS1-242	ECS1-243	ECS1-244



ROUND WITH FIN AND SPONGE CORE

CORE DIA. (D)	OVERALL WIDTH (W)				
		NEOPRENE SPONGE		SILICONE SPONGE	
		MONEL	SnCuFe	MONEL	SnCuFe
0.125 (3.18)	0.500 (12.70)	ECS1-245	ECS1-246	ECS1-247	ECS1-248
0.125 (3.18)	0.625 (15.88)	ECS1-249	ECS1-250	ECS1-251	ECS1-252
0.125 (3.18)	0.750 (19.05)	ECS1-253	ECS1-254	ECS1-255	ECS1-256
0.188 (4.78)	0.500 (12.70)	ECS1-257	ECS1-258	ECS1-259	ECS1-260
0.188 (4.78)	0.625 (15.88)	ECS1-261	ECS1-262	ECS1-263	ECS1-264
0.188 (4.78)	0.750 (19.05)	ECS1-265	ECS1-266	ECS1-267	ECS1-268
0.250 (6.35)	0.625 (15.88)	ECS1-269	ECS1-270	ECS1-271	ECS1-272
0.250 (6.35)	0.750 (19.05)	ECS1-273	ECS1-274	ECS1-275	ECS1-276
0.250 (6.35)	1.000 (25.40)	ECS1-278	ECS1-279	ECS1-280	ECS1-281
0.500 (12.70)	1.000 (25.40)	ECS1-282	ECS1-283	ECS1-284	ECS1-285
0.625 (15.88)	1.375 (34.93)	ECS1-286	ECS1-287	ECS1-288	ECS1-289



ROUND WITH SPONGE CORE

CORE DIA. (D)	PART NUMBER			
	NEOPRENE SPONGE		SILICONE SPONGE	
	MONEL	SnCuFe	MONEL	SnCuFe
0.062 (1.57)	ECS1-290	ECS1-291	ECS1-292	ECS1-293
0.125 (3.18)	ECS1-294	ECS1-295	ECS1-296	ECS1-297
0.188 (4.78)	ECS1-298	ECS1-299	ECS1-300	ECS1-301
0.250 (6.35)	ECS1-302	ECS1-303	ECS1-304	ECS1-305
0.312 (7.92)	ECS1-306	ECS1-307	ECS1-308	ECS1-309
0.375 (9.53)	ECS1-310	ECS1-311	ECS1-312	ECS1-313
0.437 (11.11)	ECS1-314	ECS1-315	ECS1-316	ECS1-317
0.500 (12.70)	ECS1-318	ECS1-319	ECS1-320	ECS1-321

OTHER CROSS SECTIONS AVAILABLE UPON REQUEST

Conduct-O-Seal Combo Gasket

ECS2 Series

The ECS2 series gaskets combine bonding mesh in parallel with an elastomer environmental sealing strip. The knitted mesh can be made from Monel, SnCuFe (tin-plated, copper-clad steel), or aluminum wire. The elastomer seal is available in silicone or neoprene, sponge or solid.

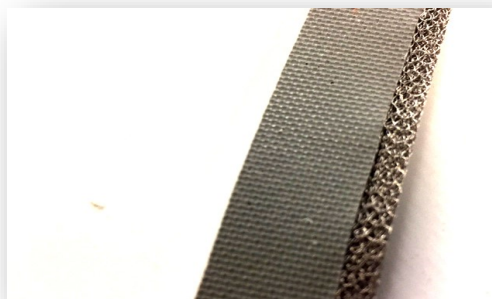

APPLICATIONS

ECS2 Series are recommended for applications which require a weather seal in addition to an EMI/EMP shielding. This type of gasketing is also useful in applications that require shielding only and where the adhesive backing on the elastomer provides convenient mounting. The uses include sealing of enclosure doors, access panels or vent panels.

AVAILABLE CONFIGURATIONS

We offer strips with an adhesive backing which allows simple application and alignment of the gasket. ECS2 Series is also available with a silicone or neoprene, solid or sponge elastomer seal. For the solid elastomer seal, the mesh is 0.032" higher than the elastomer because the solid elastomer is not easily compressed compared to the wire mesh. If sponge is needed, over-compression at the bolt holes can be eluded by bonding washer type metal compression stops within the seal.

Material Specifications

Monel Wire -.0035"/.0045 Diameter	QQ-N-281
SnCuFe Wire	ASTM-B-520, 2-3% tin plating, 30-40% copper cladding and balance of weight is steel
Aluminum Wire-.005" Diameter	Alloy 5056, AMS-4182
Tin-Plated Phosphor	Phosphor Bronze Per ASTM-B-105
Bronze Wire-.0045" Diameter	Tin-Plate Per ASTM-B-33
Neoprene Sponge Elastomer	MIL-R-6130B Type II Grade A, Condition Medium
Silicone Sponge Elastomer	AMS-3195
Neoprene Solid Elastomer	Mil-R-6855 Class II, Grade 40
Silicone Solid Elastomer	ZZ-R-765 Class 2B, Grade 40

Conduct-O-Seal Combo Gasket

ECS2 Series

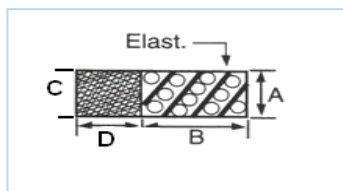

SPONGE ELASTOMER WITH MESH STRIP

ELASTOMER		MESH		WITHOUT P.S.A.				WITH P.S.A.			
HEIGHT A	WIDTH B	HEIGHT C	WIDTH D	NEOPRENE SPONGE		SILICONE SPONGE		NEOPRENE SPONGE		SILICONE SPONGE	
				MONEL	SnCuFe	MONEL	SnCuFe	MONEL	SnCuFe	MONEL	SnCuFe
0.062 (1.57)	0.250 (6.35)	0.062 (1.57)	0.125 (3.18)	ECS2-1	ECS2-2	ECS2-3	ECS2-4	ECS2-5	ECS2-6	ECS2-7	ECS2-8
0.062 (1.57)	0.375 (9.53)	0.062 (1.57)	0.125 (3.18)	ECS2-9	ECS2-10	ECS2-11	ECS2-12	ECS2-13	ECS2-14	ECS2-15	ECS2-16
0.062 (1.57)	0.500 (12.70)	0.062 (1.57)	0.125 (3.18)	ECS2-17	ECS2-18	ECS2-19	ECS2-20	ECS2-21	ECS2-22	ECS2-23	ECS2-24
0.062 (1.57)	0.625 (15.88)	0.062 (1.57)	0.125 (3.18)	ECS2-25	ECS2-26	ECS2-27	ECS2-28	ECS2-29	ECS2-30	ECS2-31	ECS2-32
0.093 (2.36)	0.250 (6.35)	0.093 (2.36)	0.125 (3.18)	ECS2-33	ECS2-34	ECS2-35	ECS2-36	ECS2-37	ECS2-38	ECS2-39	ECS2-40
0.093 (2.36)	0.375 (9.53)	0.093 (2.36)	0.125 (3.18)	ECS2-41	ECS2-42	ECS2-43	ECS2-44	ECS2-45	ECS2-46	ECS2-47	ECS2-48
0.093 (2.36)	0.500 (12.70)	0.093 (2.36)	0.125 (3.18)	ECS2-49	ECS2-50	ECS2-51	ECS2-52	ECS2-53	ECS2-54	ECS2-55	ECS2-56
0.093 (2.36)	0.750 (19.05)	0.093 (2.36)	0.125 (3.18)	ECS2-57	ECS2-58	ECS2-59	ECS2-60	ECS2-61	ECS2-62	ECS2-63	ECS2-64
0.125 (3.18)	0.125 (3.18)	0.125 (3.18)	0.125 (3.18)	ECS2-65	ECS2-66	ECS2-67	ECS2-68	ECS2-69	ECS2-70	ECS2-71	ECS2-72
0.125 (3.18)	0.188 (4.78)	0.125 (3.18)	0.125 (3.18)	ECS2-73	ECS2-74	ECS2-75	ECS2-76	ECS2-77	ECS2-78	ECS2-79	ECS2-80
0.125 (3.18)	0.250 (6.35)	0.125 (3.18)	0.125 (3.18)	ECS2-81	ECS2-82	ECS2-83	ECS2-84	ECS2-85	ECS2-86	ECS2-87	ECS2-88
0.125 (3.18)	0.250 (6.35)	0.125 (3.18)	0.250 (6.35)	ECS2-89	ECS2-90	ECS2-91	ECS2-92	ECS2-93	ECS2-94	ECS2-95	ECS2-96
0.125 (3.18)	0.375 (9.53)	0.125 (3.18)	0.125 (3.18)	ECS2-97	ECS2-98	ECS2-99	ECS2-100	ECS2-101	ECS2-102	ECS2-103	ECS2-104
0.125 (3.18)	0.500 (12.70)	0.125 (3.18)	0.125 (3.18)	ECS2-105	ECS2-106	ECS2-107	ECS2-108	ECS2-109	ECS2-110	ECS2-111	ECS2-112
0.125 (3.18)	0.500 (12.70)	0.125 (3.18)	0.250 (6.35)	ECS2-113	ECS2-114	ECS2-115	ECS2-116	ECS2-117	ECS2-118	ECS2-119	ECS2-120
0.125 (3.18)	0.500 (12.70)	0.125 (3.18)	0.500 (12.70)	ECS2-121	ECS2-122	ECS2-123	ECS2-124	ECS2-125	ECS2-126	ECS2-127	ECS2-128
0.125 (3.18)	0.625 (15.88)	0.125 (3.18)	0.125 (3.18)	ECS2-129	ECS2-130	ECS2-131	ECS2-132	ECS2-133	ECS2-134	ECS2-135	ECS2-136
0.125 (3.18)	0.750 (19.05)	0.125 (3.18)	0.125 (3.18)	ECS2-137	ECS2-138	ECS2-139	ECS2-140	ECS2-141	ECS2-142	ECS2-143	ECS2-144
0.188 (4.78)	0.188 (4.78)	0.188 (4.78)	0.125 (3.18)	ECS2-145	ECS2-146	ECS2-147	ECS2-148	ECS2-149	ECS2-150	ECS2-151	ECS2-152
0.188 (4.78)	0.250 (6.35)	0.188 (4.78)	0.125 (3.18)	ECS2-153	ECS2-154	ECS2-155	ECS2-156	ECS2-157	ECS2-158	ECS2-159	ECS2-160
0.188 (4.78)	0.375 (9.53)	0.188 (4.78)	0.125 (3.18)	ECS2-161	ECS2-162	ECS2-163	ECS2-164	ECS2-165	ECS2-166	ECS2-167	ECS2-168
0.188 (4.78)	0.500 (12.70)	0.188 (4.78)	0.125 (3.18)	ECS2-169	ECS2-170	ECS2-171	ECS2-172	ECS2-173	ECS2-174	ECS2-175	ECS2-176
0.188 (4.78)	0.750 (19.05)	0.188 (4.78)	0.250 (6.35)	ECS2-177	ECS2-178	ECS2-179	ECS2-180	ECS2-181	ECS2-182	ECS2-183	ECS2-184
0.250 (6.35)	0.250 (6.35)	0.250 (6.35)	0.125 (3.18)	ECS2-185	ECS2-186	ECS2-187	ECS2-188	ECS2-189	ECS2-190	ECS2-191	ECS2-192
0.250 (6.35)	0.500 (12.70)	0.250 (6.35)	0.125 (3.18)	ECS2-193	ECS2-194	ECS2-195	ECS2-196	ECS2-197	ECS2-198	ECS2-199	ECS2-200
0.250 (6.35)	0.750 (19.05)	0.250 (6.35)	0.125 (3.18)	ECS2-201	ECS2-202	ECS2-203	ECS2-204	ECS2-205	ECS2-206	ECS2-207	ECS2-208
0.375 (9.53)	0.250 (6.35)	0.375 (9.53)	0.125 (3.18)	ECS2-209	ECS2-210	ECS2-211	ECS2-212	ECS2-213	ECS2-214	ECS2-215	ECS2-216
0.375 (9.53)	0.500 (12.70)	0.375 (9.53)	0.250 (6.35)	ECS2-217	ECS2-218	ECS2-219	ECS2-220	ECS2-221	ECS2-222	ECS2-223	ECS2-224
0.375 (9.53)	0.750 (19.05)	0.375 (9.53)	0.250 (6.35)	ECS2-225	ECS2-226	ECS2-227	ECS2-228	ECS2-229	ECS2-230	ECS2-231	ECS2-232

NOTE- DIMENSIONS ARE IN INCHES AND (MM) / SPONGE ELASTOMER WITH TWO MESH STRIPS ALSO AVAILABLE UPON REQUEST

Conduct-O-Seal Combo Gasket

ECS2 Series

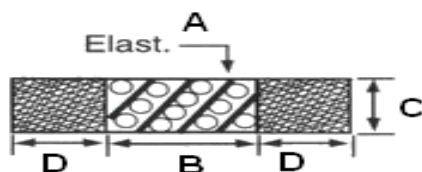

SPONGE ELASTOMER WITH TWO MESH STRIPS

ELASTOMER		MESH		WITHOUT P.S.A.				WITH P.S.A.			
				NEOPRENE SPONGE		SILICONE SPONGE		NEOPRENE SPONGE		SILICONE SPONGE	
HEIGHT A	WIDTH B	HEIGHT C	WIDTH D	MONEL	SnCuFe	MONEL	SnCuFe	MONEL	SnCuFe	MONEL	SnCuFe
0.093 (2.36)	0.250 (6.35)	0.093 (2.36)	0.125 (3.18)	ECS2-233	ECS2-234	ECS2-235	ECS2-236	ECS2-237	ECS2-238	ECS2-239	ECS2-240
0.093 (2.36)	0.375 (9.53)	0.093 (2.36)	0.125 (3.18)	ECS2-241	ECS2-242	ECS2-243	ECS2-244	ECS2-245	ECS2-246	ECS2-247	ECS2-248
0.093 (2.36)	0.500 (12.70)	0.093 (2.36)	0.125 (3.18)	ECS2-249	ECS2-250	ECS2-251	ECS2-252	ECS2-253	ECS2-254	ECS2-256	ECS2-257
0.093 (2.36)	0.750 (19.05)	0.093 (2.36)	0.125 (3.18)	ECS2-258	ECS2-259	ECS2-260	ECS2-261	ECS2-262	ECS2-263	ECS2-264	ECS2-265
0.125 (3.18)	0.125 (3.18)	0.125 (3.18)	0.125 (3.18)	ECS2-266	ECS2-267	ECS2-268	ECS2-269	ECS2-270	ECS2-271	ECS2-272	ECS2-273
0.125 (3.18)	0.188 (4.78)	0.125 (3.18)	0.125 (3.18)	ECS2-274	ECS2-275	ECS2-276	ECS2-277	ECS2-278	ECS2-279	ECS2-280	ECS2-281
0.125 (3.18)	0.250 (6.35)	0.125 (3.18)	0.125 (3.18)	ECS2-282	ECS2-283	ECS2-284	ECS2-285	ECS2-286	ECS2-287	ECS2-288	ECS2-289
0.125 (3.18)	0.250 (6.35)	0.125 (3.18)	0.250 (6.35)	ECS2-290	ECS2-291	ECS2-292	ECS2-293	ECS2-294	ECS2-295	ECS2-296	ECS2-297
0.125 (3.18)	0.375 (9.53)	0.125 (3.18)	0.125 (3.18)	ECS2-298	ECS2-299	ECS2-300	ECS2-301	ECS2-302	ECS2-303	ECS2-304	ECS2-305
0.125 (3.18)	0.500 (12.70)	0.125 (3.18)	0.125 (3.18)	ECS2-306	ECS2-307	ECS2-308	ECS2-309	ECS2-310	ECS2-311	ECS2-312	ECS2-313
0.125 (3.18)	0.500 (12.70)	0.125 (3.18)	0.250 (6.35)	ECS2-314	ECS2-315	ECS2-316	ECS2-317	ECS2-318	ECS2-319	ECS2-320	ECS2-321
0.125 (3.18)	0.500 (12.70)	0.125 (3.18)	0.500 (12.70)	ECS2-322	ECS2-323	ECS2-324	ECS2-325	ECS2-326	ECS2-327	ECS2-328	ECS2-329
0.125 (3.18)	0.625 (15.88)	0.125 (3.18)	0.125 (3.18)	ECS2-340	ECS2-341	ECS2-342	ECS2-343	ECS2-344	ECS2-345	ECS2-346	ECS2-347
0.125 (3.18)	0.750 (19.05)	0.125 (3.18)	0.125 (3.18)	ECS2-348	ECS2-349	ECS2-350	ECS2-351	ECS2-352	ECS2-353	ECS2-354	ECS2-355
0.188 (4.78)	0.188 (4.78)	0.188 (4.78)	0.125 (3.18)	ECS2-356	ECS2-357	ECS2-358	ECS2-359	ECS2-360	ECS2-361	ECS2-362	ECS2-363
0.188 (4.78)	0.250 (6.35)	0.188 (4.78)	0.125 (3.18)	ECS2-364	ECS2-365	ECS2-366	ECS2-367	ECS2-368	ECS2-369	ECS2-370	ECS2-371
0.188 (4.78)	0.375 (9.53)	0.188 (4.78)	0.125 (3.18)	ECS2-372	ECS2-373	ECS2-374	ECS2-375	ECS2-376	ECS2-378	ECS2-379	ECS2-380
0.188 (4.78)	0.500 (12.70)	0.188 (4.78)	0.125 (3.18)	ECS2-381	ECS2-382	ECS2-383	ECS2-384	ECS2-385	ECS2-386	ECS2-387	ECS2-388
0.188 (4.78)	0.750 (19.05)	0.188 (4.78)	0.250 (6.35)	ECS2-389	ECS2-390	ECS2-391	ECS2-392	ECS2-393	ECS2-394	ECS2-395	ECS2-396
0.250 (6.35)	0.250 (6.35)	0.250 (6.35)	0.125 (3.18)	ECS2-397	ECS2-398	ECS2-399	ECS2-400	ECS2-401	ECS2-402	ECS2-403	ECS2-404
0.250 (6.35)	0.500 (12.70)	0.250 (6.35)	0.125 (3.18)	ECS2-405	ECS2-406	ECS2-407	ECS2-408	ECS2-409	ECS2-410	ECS2-411	ECS2-412
0.250 (6.35)	0.750 (19.05)	0.250 (6.35)	0.125 (3.18)	ECS2-413	ECS2-414	ECS2-415	ECS2-416	ECS2-417	ECS2-418	ECS2-419	ECS2-420

DIFFERENT PROFILES AVAILABLE UPON REQUEST

Conduct-O-Elastomer

ECS3 Series

ECS has developed a line of conductive silicone elastomers that are designed to meet the requirements outlined for the MIL-G-83528 specification. Our conductive materials are used to produce shielding gaskets for Military, Aerospace, electronics, and communications applications. Our range of conductive silicones has expanded to include materials that are designed to balance requirements for electrical conductivity and cost performance for the commercial sector.

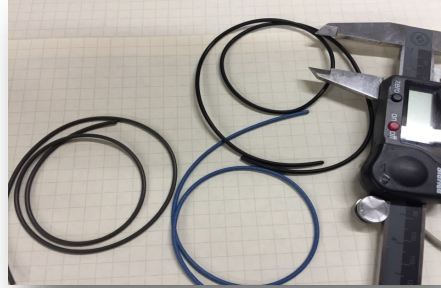

SOLID ROUND

M83528/001

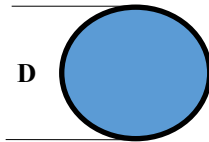

EXTRUSION STANDARD PROFILES

D	PART	M83528/	D	PART	M83528/	D	PART	M83528/
.040	ECS3-10	1/001	.103	ECS3-16	1/007	.150	ECS3-21	N/A
.053	ECS3-11	1/002	.112	ECS3-17	N/A	.160	ECS3-22	N/A
.062	ECS3-12	1/003	.119	ECS3-17	1/008	.188	ECS3-23	1/011
.070	ECS3-13	1/004	.125	ECS3-18	1/009	.216	ECS3-24	1/012
.080	ECS3-14	1/005	.130	ECS3-19	N/A	.250	ECS3-25	1/013
.093	ECS3-15	1/006	.139	ECS3-20	1/010	-	-	-

HOLLOW ROUND

M83528/011

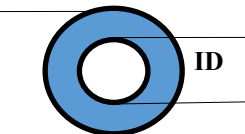

O.D. (in.)	I.D. (in.)	PART NO.	M83528/
.070	.025	ECS3-26	N/A
.093	.035	ECS3-27	N/A
.103	.040	ECS3-28	11/007
.125	.045	ECS3-29	11/001
.125	.062	ECS3-30	11/006
.156	.050	ECS3-31	11/002
.177	.079	ECS3-32	11/008
.250	.125	ECS3-33	11/003
.312	.192	ECS3-34	11/004
.375	.250	ECS3-35	11/005
.437	.250	ECS3-36	N/A

When ordering, please use full product number & material requesting i.e.;

ECS3-10-2000 - 2000 = Nickel Graphite

Please see Material Selection page on the last page (7) of Conduct-O-Elastomer section

Conduct-O-Elastomer Extrusion Profiles ECS3 Series

RECTANGULAR SOLID

M83528/009

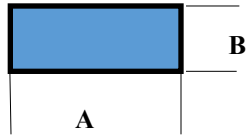

A	B	PART NO.	M83528/
.032	.032	ECS3-36	N/A
.063	.042	ECS3-37	9/001
.095	.062	ECS3-38	9/002
.120	.075	ECS3-39	9/003
.125	.062	ECS3-40	9/004
.156	.062	ECS3-41	9/005
.250	.062	ECS3-42	9/006
.500	.075	ECS3-43	9/007
.500	.125	ECS3-44	9/008
.500	.188	ECS3-45	9/009
.750	.062	ECS3-46	9/010
.880	.062	ECS3-47	9/011
1.000	.250	ECS3-48	9/012
1.180	.062	ECS3-49	9/013
.060	.080	ECS3-50	N/A

SOLID D SHAPE

M83528/003

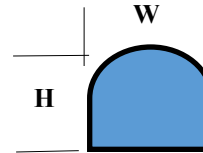

H	W	PART NO.	M83528/
.064	.055	ECS3-51	N/A
.068	.062	ECS3-52	3/001
.068	.062	ECS3-53	N/A
.078	.094	ECS3-54	3/002
.089	.078	ECS3-55	3/003
.094	.094	ECS3-56	3/004
.100	.062	ECS3-57	3/005
.110	.150	ECS3-58	3/006
.131	.122	ECS3-59	N/A
.136	.124	ECS3-60	3/007
.156	.118	ECS3-61	3/008
.156	.156	ECS3-62	3/009
.175	.178	ECS3-63	3/010
.188	.188	ECS3-64	3/011
.250	.250	ECS3-65	3/012

HOLLOW D SHAPE

M83528/007

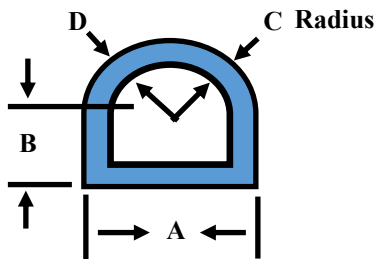

A	B	C	D	PART NO.	M83528/
.156	.045	.078	.045	ECS3-66	N/A
.156	.078	.078	.045	ECS3-67	7/001 A
.187	.093	.093	.050	ECS3-68	7/002 A
.250	.125	.125	.065	ECS3-69	7/007 A
.312	.156	.156	.062	ECS3-70	7/003 A
.487	.244	.244	.080	ECS3-71	7/004 B
.487	.080	.244	.080	ECS3-72	7/006 A
.312	.200	.112	.062	ECS3-73	7/005 A

Conduct-O-Elastomer

Molded Sheet Part Numbers

ECS3 Series

For ordering convenience please see our full product part number list below. All part numbers are individually numbered to designate material type, durometer, thickness, and mold dimension. Please see the example of our part number system below or simply call direct for assistance.

Keep in mind addition of PSA and custom mold size is available by request as always.

Continuous Roll Stock is also available up to 15" WD

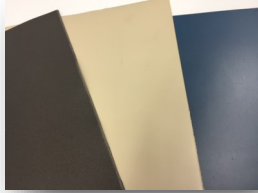

Sheet Thickness & Dimensions ECS Material Durometer (Shore A)



ECS3- _____ - _____ - _____

Series	Thickness	Sheet Dimensions	Material - Durometer
ECS3	.020	15" x 20" 24" x 26"	1000-70
	.032		2000-65
	.040		2000F-60
	.045		5000-65*
	.062		5000F-70*
	.093		6000-65
	.125		7000-65
	.188		8000-65*
	.250		8000-85*

* M83528/015 Certified Material

Conduct-O-Elastomer Specifications

ECS3 Series

	Carbon 1000	Nickel Graphite 2000	Nickel Graphite 2000F	Silver Aluminum 5000*	Silver Aluminum 5000F*	Silver Glass 6000	Silver Copper 8000*
Elastomer	Silicone	Silicone	Fluoro- silicone	Silicone	Fluoro- silicone	Sili- cone	Silicone
Color	Black	Dark Gray	Dark Gray	Blue*	Blue*	Tan	Tan
Specific Gravity, gm/cc	1.2	1.95	1.95	2.0	2.0	1.9	3.5
Durometer Shore A	70	30-70	65	65	70	65	65
Volume Resistivity, Ohm- cm	7.0	0.10	0.10	0.008	0.012	0.006	0.004
Operating Temperature: Min C	-55°	-55°	-55°	-55°	-55°	-55°	-55°
Operating Temperature: Max C	200°	150°	150°	160°	160°	160°	125°
Compression Deflection % Min.	3.5	3.5	3.0	3.5	3.5	3.5	3.5
Tensile Strength, P.S.I.	650	150	150	200	180	200	200
Elongation % Min.	100%	100%	100%	100%	60%	100%	100%
Elongation % Max.	-	-	-	300%	260%	300%	300%
Compression Set %	40	35	25	32	30	30	32
Tear Strength lb./in.	40	40	35	30	35	30	25
Shielding Effectiveness (100 Mhz)	80	100	100	120	120	100	120
Shielding Effectiveness (500 Mhz)	80	100	100	120	120	100	120
Shielding Effectiveness (2 Ghz)	60	100	100	115	115	90	120
Shielding Effectiveness (10 Ghz)	50	100	100	115	115	90	120

* See next page for actual data (MIL-DTL-83528H Qualifying results for types A, B, D, & K) *

EAST COAST SHIELDING
Qualifying Data for Types A, B, D, & K

	Silver Aluminum 5000-65 (Type B)	Silver Aluminum 5000F-70 (Type D)	Silver Copper 8000-65 (Type A)	Silver Copper 8000-85 (Type K)
Elastomer	Silicone	Fluorosilicone	Silicone	Silicone
Color	Blue	Blue	Tan	Tan
Specific Gravity, g/cc	2.0689	2.1998	3.5976	3.6612
Durometer, Shore A	67.66	70	71.33	81.33
Volume Resistivity, ohm-cm	.00278	.00326	.00107	.00127
Compression Deflection, %	16.66	13.217	12.793	12.793
Tensile Strength, PSI	278.108	330.137	353.004	602.853
Elongation, %	222.282	190.895	254.002	265.042
Compression Set, %	12.74	21.08	25.1533	25.6933
Tear Strength, lb./in.	53.192	66.972	54.837	81.169
Electrical Stability After Break, ohm-cm	.00295	.0072	.00097	.00186
Vibration, Ohm-cm During/After	.00719/.00126	.00213/.00089	.00279/.000413	.00145/.00045
Low Temp. Flex, °C TR10/TR70	-70 °C/-65 °C	-67.6 °C/-61.33 °C	-69 °C/-69 °C	-69.8 °C/-69.8 °C
Life Testing, Ohm-cm	.0046	.00632	.00548	.00616
EMP, Ohm-cm	.0083	.0103	.0053	.005
Fluid Immersion, Survivability	Not Survivable	Survivable	Not Survivable	Not Survivable
Shielding Effectiveness, 100 MHz	125	119	125	127
Shielding Effectiveness, 500 MHz	120	121	131	134
Shielding Effectiveness, 2 GHz	123	123	120	132
Shielding Effectiveness, 10 GHz	122	121	126	128

Conduct-o-Seal Oriented Wire in Silicone Gasket Material ECS4 Series

East Coast Shielding Oriented wire in silicone ECS4 Series gasketing material is a combination EMI shield and environmental pressure seal. Produced on location, this product is fabricated with individual wires positioned perpendicular to the flange mating surface and is crimped to enhance proper contact. Available in a solid silicone, fluorosilicone or sponge silicone binder, East Coast Shielding can accommodate you with the proper material to make your application successful.

Applications:

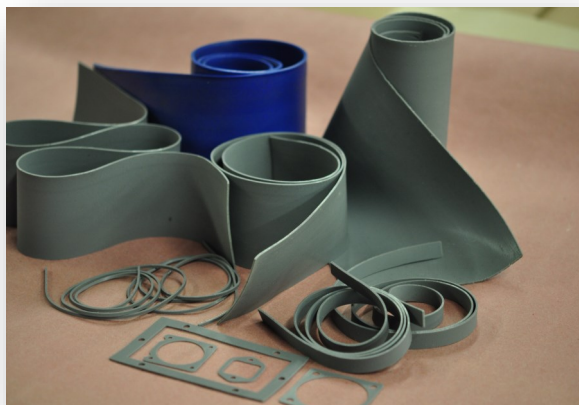

East Coast Shielding Oriented Wire in Silicone **ECS4 Series** is recommended for industrial, military and commercial applications requiring EMI shielding and environmental sealing with a low to moderate closure force. Oriented wire in sponge silicone is designed for applications with severe joint unevenness, require low closure force, have a 5 psi maximum operating pressure or generally require a greater compressibility than a solid silicone. Oriented wire in solid silicone is designed for applications requiring moderate closure force, high operating pressure and a wider temperature range.

East Coast Shielding Oriented Wire in Silicone can be fabricated using 0.0045" (0.1144 mm) diameter Monel wire, 0.0045" (0.1144 mm) diameter phosphor bronze wire, or 0.005" (0.1271 mm) aluminum wire. The elastomer binder is available in solid silicone, solid fluorosilicone or sponge silicone. Pressure sensitive adhesive is also available on strips and sheets.

Oriented wire in silicone is available in sheets and strips with the height and width listed in the table on the following page. For sponge silicone widths larger 3" the sheets can be vulcanized or bonded together. For solid silicone widths larger than 9" the sheets can be vulcanized or bonded together also. Also available are die-cut parts or custom fabricated designs to meet your specific requirements.



Proudly Made in Johnsonburg, NJ.

Conduct-o-Seal Oriented Wire in Silicone Gasket Material

ECS4 Series

Oriented Wire in Silicone

Solid & Sponge Strip P/N's

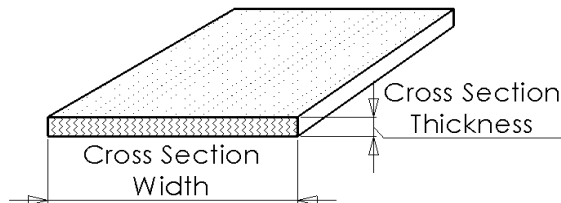

Thickness Inches	Width Inches	Silicone Solid	Silicone Sponge	Thickness Inches	Width Inches	Silicone Solid	Silicone Sponge
0.062	0.093	ECS4-001	ECS4-002	0.032	3"	ECS4-075	ECS4-076
0.062	0.125	ECS4-003	ECS4-004	0.032	4.5"	ECS4-077	ECS4-078
0.062	0.188	ECS4-005	ECS4-006	0.032	6"	ECS4-079	ECS4-080
0.062	0.25	ECS4-007	ECS4-008	0.032	9"	ECS4-081	ECS4-082
0.062	0.312	ECS4-009	ECS4-010	0.045	3"	ECS4-083	ECS4-084
0.062	0.375	ECS4-011	ECS4-012	0.045	4.5"	ECS4-085	ECS4-086
0.062	0.5	ECS4-013	ECS4-014	0.045	6"	ECS4-087	ECS4-088
0.062	0.625	ECS4-015	ECS4-016	0.045	9"	ECS4-089	ECS4-090
0.093	0.093	ECS4-017	ECS4-018	0.055	3"	ECS4-091	ECS4-092
0.093	0.125	ECS4-019	ECS4-020	0.055	4.5"	ECS4-093	ECS4-094
0.093	0.188	ECS4-021	ECS4-022	0.055	6"	ECS4-095	ECS4-096
0.093	0.25	ECS4-023	ECS4-024	0.055	9"	ECS4-097	ECS4-098
0.093	0.312	ECS4-025	ECS4-026	0.062	3"	ECS4-099	ECS4-100
0.093	0.375	ECS4-027	ECS4-028	0.062	4.5"	ECS4-101	ECS4-102
0.093	0.5	ECS4-029	ECS4-030	0.062	6"	ECS4-103	ECS4-104
0.093	0.625	ECS4-031	ECS4-032	0.062	9"	ECS4-105	ECS4-106
0.125	0.125	ECS4-033	ECS4-034	0.093	3"	ECS4-107	ECS4-108
0.125	0.188	ECS4-035	ECS4-036	0.093	4.5"	ECS4-109	ECS4-110
0.125	0.25	ECS4-037	ECS4-038	0.093	6"	ECS4-111	ECS4-112
0.125	0.312	ECS4-039	ECS4-040	0.093	9"	ECS4-113	ECS4-114
0.125	0.375	ECS4-041	ECS4-042	0.125	3"	ECS4-115	ECS4-116
0.125	0.5	ECS4-043	ECS4-044	0.125	4.5"	ECS4-117	ECS4-118
0.125	0.625	ECS4-045	ECS4-046	0.125	6"	ECS4-119	ECS4-120
0.156	0.125	ECS4-047	ECS4-048	0.125	9"	ECS4-121	ECS4-122
0.188	0.125	ECS4-049	ECS4-050	0.156	3"	ECS4-123	ECS4-124
0.188	0.188	ECS4-051	ECS4-052	0.156	4.5"	ECS4-125	ECS4-126
0.188	0.25	ECS4-053	ECS4-054	0.156	6"	ECS4-127	ECS4-128
0.188	0.312	ECS4-055	ECS4-056	0.156	9"	ECS4-129	ECS4-130
0.188	0.375	ECS4-057	ECS4-058	0.188	3"	ECS4-131	ECS4-132
0.188	0.5	ECS4-059	ECS4-060	0.188	4.5"	ECS4-133	ECS4-134
0.188	0.625	ECS4-061	ECS4-062	0.188	6"	ECS4-135	ECS4-136
0.25	0.125	ECS4-063	ECS4-064	0.188	9"	ECS4-137	ECS4-138
0.25	0.188	ECS4-065	ECS4-066	0.25	3"	ECS4-139	ECS4-140
0.25	0.25	ECS4-067	ECS4-068	0.25	4.5"	ECS4-141	ECS4-142
0.25	0.312	ECS4-069	ECS4-070	0.25	6"	ECS4-143	ECS4-144
0.25	0.375	ECS4-071	ECS4-072	0.25	9"	ECS4-145	ECS4-146
0.312	0.5	ECS4-073	ECS4-074				

ADD : -M for Monel / -A for Aluminum / -0 for Plain / -1 For PSA Backing / For Example : ECS4-001-M-1

Conduct-o-Seal Oriented Wire in Silicone Gasket Material ECS4 Series

Material Specifications

	Solid Silicone/ Monel Wire	Sponge Silicone/ Monel Wire	Solid Silicone/ Aluminum	Sponge Silicone/ Aluminum
Shielding db: 200 Khz	70	70	70	70
100 Mhz	110	108	101	108
1 Ghz	111	106	110	112
Closing Force (psi)	25-100	25-100	15-75	15-75
Compression Set (@50psi)	2%	5%	2%	5%
EMP Survivability/ Color	yes Grey	yes Grey	yes Grey	yes Grey

Solid Silicone	A-A-59588, Class II, Grade 40 (Formerly ZZ-R-765)
Temperature Range	-70°C to 205°C
Sponge Silicone	AMS—3195
Temperature Range	-60°C to 205°C
Aluminum Wire	AMS 4182, Alloy 5056
Monel Wire	QQ-N-281 Class A
Wire Density / sq. in.	
Silicone Solid	900 ± 15%
Silicone Sponge	600 ± 15%
Seal	Waterproof

Strips and Sheets Cross Section Tolerances		
Dimension	Height	Width
0.032" (0.81)	± .010" (.25)	± .015" (.38)
0.126" (3.20)	± .010" (.25)	± .032" (.81)
0.251" (6.38)	-	± .047" (1.19)
3" (76.20)	-	± .13 (3.30)
4.5" (114.30)	-	± .19" (4.83)
6" (152.0)	-	± .25" (6.35)
9" (228.60)	-	± .38" (9.65)

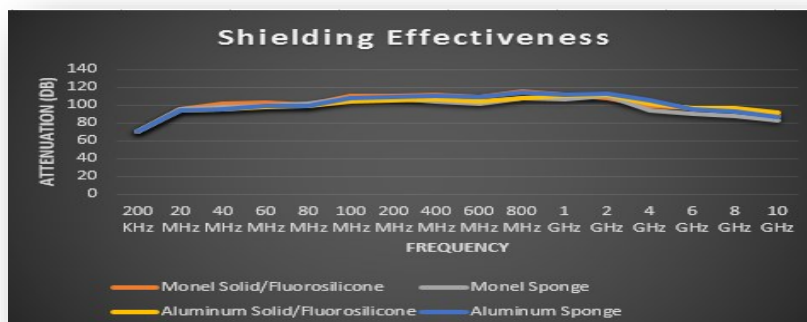

Conduct-o-Seal Oriented Wire in Silicone Gasket Material ECS4 Series

EMI/RFI Shielding Material

East Coast Shielding offers **ECS4 Series** oriented wire available in silicone, fluorosilicone or AMS-3195 spec grade sponge silicone. Available with Monel or Aluminum wire conductors, Series 150 oriented wire in silicone is capable of withstanding temperature extremes of -70°C to $+205^{\circ}\text{C}$ due to the special characteristics of the silicone polymer used. This material is ideal for use in applications that require an environmental seal as well as EMI protection. It is also ideal for use on flanges or irregular shapes where a die cut gasket is required to match the flange contour.

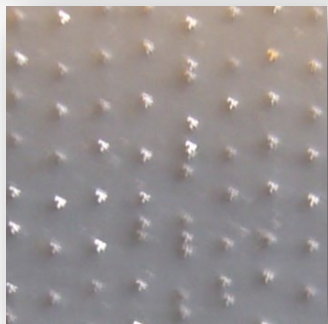
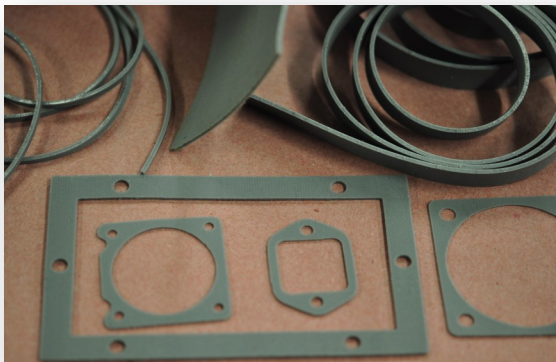

Oriented Wire in Silicone Solid



Oriented Wire in Silicone Sponge

Monel or Aluminum wire is processed with and bonded to a high quality silicone elastomer for uniform surface and multiple “spring” effect with each contact point.

Advantages

- ⇒ Superior protection: Shields from harsh weather and electronic interference, up to 100db in the E-Field, up to 50 db in the H-Field.
- ⇒ Custom configurations: ECS4 Series is also available in die-cut shapes to match complex flange contours, or strips assembled and bonded into a specific configuration.
- ⇒ Material can be sliced down to a thickness of .030”
- ⇒ To provide both EMI shielding and an environmental seal on cast or machined surfaces. Bonded frame configurations can be used with pre-cast housings, vent panels, and computer terminal window frames. Die cut wall widths as low as 0.090 (2,27) wide. Some examples would include circular military connectors and sub "D" connectors.

Conduct-o-Seal Oriented Wire in Silicone Gasket Material

ECS4 Series

Application Design Data

Oriented Wire Gaskets are recommended for applications requiring EMI suppression, grounding and environmental sealing. Presented in this section is a guide to compression stop applications, various splicing techniques and fabricated gasket design.

Compression Stops

The use of disk or washer type compression stops can be provided as part of the gasket assembly in order to avoid over-compression of the gasket and bowing of the cover plate. Compression stops are fabricated from sheets, rod or tubing material using either aluminum or stainless steel.

Typical compression stop assemblies are shown in Figures 1a and 1b.

Figure 1a. Disc type compression stop

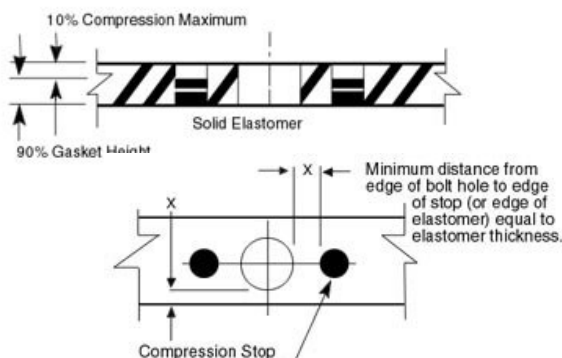
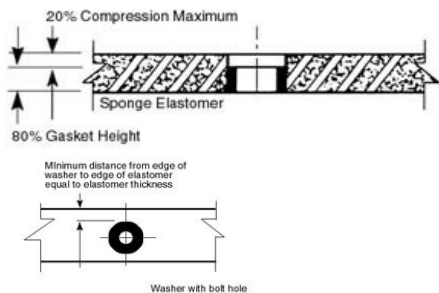

Figure 1b. Washer type compression stop



Fabricated Oriented Wire Gasket

East Coast Shielding can supply fabricated gaskets to fit your enclosure size and mounting criteria. Figure 2 is common oriented wire gasket construction with bolt and/or slotted hole design to meet your specific requirements.

Figure 2. Oriented Wire Gasket

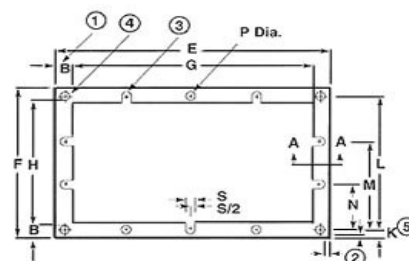

Dimensional Location	Size Range with Tolerance		
	0-4"	4.1-12.0"	12.1-24.0"
F,H,E,G	Length & Width (0-101,6)	(104,1-304,8)	(307,3-609,6)
K,N,M,L	Hole Location (+,-,25)	(+,-,38)	(+,-,51)

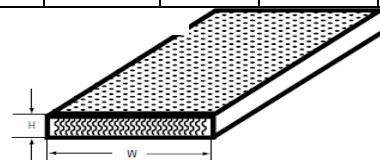

Notes:

1. Minimum sealing gasket width is 0.125 in. (3,18 mm) but not less than gasket thickness.
2. Minimum distance from bolt hole or compression stop to edge of sealing gasket is not less than thickness of elastomer material.

Conduct-o-Seal Oriented Wire in Silicone Gasket Material ECS4 Series

Die Cut Gasket

Oriented wire can be supplied as a die cut gasket in various configurations. Gasket sizes are available up to 9.0" (228,6 mm) x 36.0" (914,4 mm).

Several of the most common die cut gaskets are for cable connectors and Sub-D connections shown in Figures 3a and 3b.

Figure 3a.

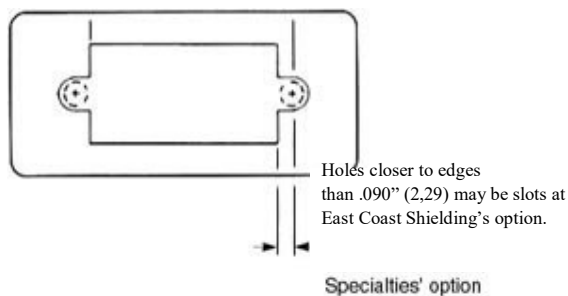
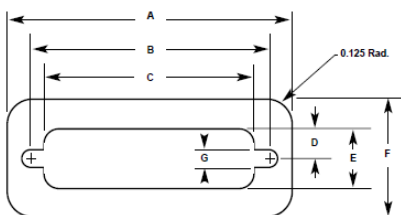
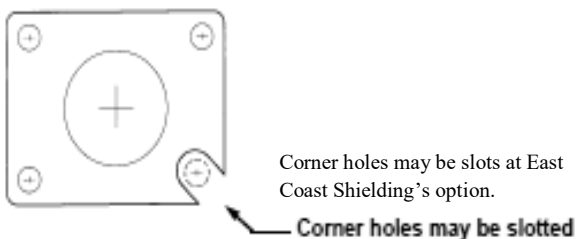

Figure 3b.



Splicing Techniques

Oriented wire can be supplied as a one piece joint-less gasket. Gasket sizes are available up to 9.0" (228,6 mm) x 36.0" (914,4 mm).

Larger gaskets are normally spliced using one of the splicing techniques shown in Figure 4. These splicing methods minimize material waste when compared to joint-less gasket design. When preparing gasket drawings, indicate the splicing method, if allowed, and desired locations.

Figure 4.

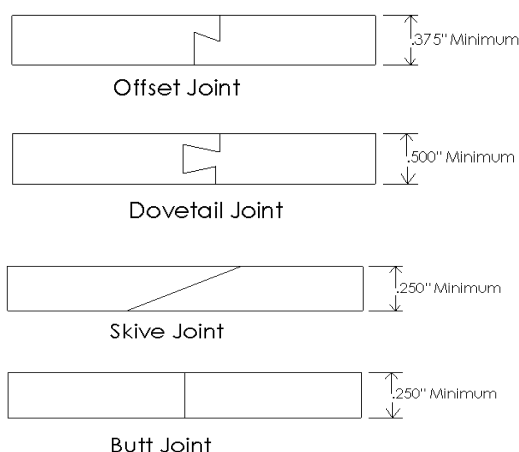

Conduct-o-Seal Oriented Wire in Silicone Gasket Material ECS4 Series

Electrical Wire Oriented Characteristics	
Shielding Effectiveness	
Transfer Impedance (500 MHz)	60 - 100 dB
H-field (200Khz) Mil 285	25 - 70 dB
Plane Wave (3 GHz)	30 - 100 dB
Surface Resistivity	N/A
Volume Resistivity	0.006 ohm/cm
Mechanical	
Available Size Range	0.032 - 0.250 (0,81 - 6,25) Thick
Deflection Operating Range	10 - 20% Deflection
Compression Force (based on shape selection)	25 - 100 PSI (172 - 689 KPa)
Compression Set	2 - 5% @ 50 PSI (344,5 KPa)
Joint Unevenness Accommodation	0.005 - 0.015 (0,13 - 0,38)
Compound/Material Availability	Elastomer: silicone - solid or sponge, fluorosilicone. Wire: Monel, aluminum
Temperature Range	-94 to + 401°F (-70 - 205°C)
Available Profiles	Rectangular, strip, flat sheets, die cut shapes, fabricated gaskets
Mounting Methods	Groove, pressure sensitive adhesive
Custom Shape Available	Complex die cut shapes, bonded or vulcanized
Environmental	
Fluid Seal	Moisture and rain, solvents (fluoro)
Air/Dust	Provides barrier against dust
Galvanic Compatibility	Monel and aluminum wire are compatible with a broad range of mating surfaces.
Applications	
Typical Applications for Shielding Gaskets	To provide both EMI shielding and an environmental seal on cast or machined surfaces. Vulcanized frame configurations can be used with pre-cast housings, vent panels, and computer terminal window frames. Die cut wall widths as low as 0.090 (2,27) wide. Some examples would include circular military connectors and sub "D" connectors.

Conduct-O-Mesh Tape

ECS5 Series



ECS5 is available in Monel or SnCuFe (tin-plated, copper-clad steel) wire. ECS5 Mesh Tape is used for wrapping cable assemblies and provides excellent shielding characteristics. ECS5 Mesh can be purchased as a double layer knitted wire mesh tape.

ECS5 MESH AVAILABLE CONFIGURATIONS

ECS5 Knitted wire mesh tape is available in 25 foot, 50 foot and 100 foot rolls.

Width	Monel Wire #	SnCuFe #	Aluminum #
.500"	ECS5-10	ECS5-11	ECS5-12
.625"	ECS5-13	ECS5-14	ECS5-15
.750"	ECS5-16	ECS5-17	ECS5-18
1.00"	ECS5-19	ECS5-20	ECS5-21
1.25"	ECS5-22	ECS5-23	ECS5-24
1.50"	ECS5-25	ECS5-26	ECS5-27
2.00"	ECS5-28	ECS5-29	ECS5-30
3.00"	ECS5-31	ECS5-32	ECS5-33

ECS5 Tape Shielding Performances

MATERIAL:	MONEL	SnCuFe	ALUMINUM
Shielding dB: 100 KHz	45	50	40
10 MHz	115	115	100
500 MHz	110	110	90
1 GHz	95	95	80
Closure Force: (min psi)	10	10	10

Conduct-O-Woven Aluminum

ECS 6 Series

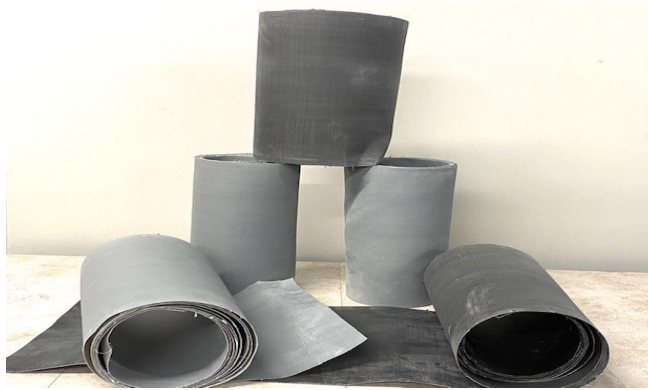

ECS 6 Series gaskets and gasketing material are fabricated from neoprene or silicone and fluorosilicone filled woven aluminum screen.

APPLICA-TIONS:

ECS 6 Series is recommended for applications requiring EMI shielding of seams with up to 0.002" of joint unevenness that require a pressure seal. ECS 6 Series filled with neoprene solid is recommended for applications requiring an operating temperature range of -40 to + 255 F. ECS 6 Series filled with silicone solid is recommended for applications requiring an operating temperature range of -65 to + 500 F. ECS 6 Fluorosilicone is recommended for use when oils , gas and solvents are present.

MATERIAL SPECIFICATIONS

ALUMINUM SCREEN	AMS-4182 WOVEN SCREEN
NEOPRENE SOLID FILLER	AMS-3222C
SILICONE SOLID FILLER	AMS-3302
FLUOROSILICONE	MIL-R-25988

ECS 6 Series is available for delivery in the materials and sizes listed in table below. ECS 6 gasketing material can be supplied in 11.25" wide rolls or can be custom die-cut to your specifications. For custom die-cut gaskets, please submit a drawing of the gasket and the type of material required.

AVAILABLE CONFIGURAIONS

THICKNESS	WIDTH	FILLER	PART NO.
.020 ± .004"	11.25 ± .25"	SILICONE	ECS6-0001
.020 ± .004"	11.25 ± .25"	NEOPRENE	ECS6-0002
.020 ± .004"	11.25 ± .25"	FLUOROSILICONE	ECS6-0003

OPTICAL Filters For Electronic Displays

ECS180 Series



East Coast Shielding is the exclusive national distributor for Instrument Plastics Limited, Maidenhead, Berkshire, UK

We are pleased to offer the complete line of Instrument Plastics' Optolite Enhancement Filters, Shielded Windows, Instrument Glasses and Polarized Filters for use in your electronic display applications.

East Coast Shielding & Instrument Plastics Limited offer prototypes and low volume production as well as large volume production of filters, displays & laminates. We can also offer special filters in all qualities to meet the customer's specifications.

Lead Times are typically 3 weeks for delivery from date of order placed. Longer lead times may be necessary for large batches or more technically involved parts.

OPTOPLITE HSR (High Scratch Resistance)

Optolite HSR is a plastic material (CR39) developed to be optically clear with excellent contrast enhancement. It is both scratch & chemical resistant without the need for hard coating. HSR can be cast between glass molds in common sheet thickness ranging from 0.5mm to 8mm. HSR can be gently formed to large radius curves in one plane if needed.

Thickness tolerance +/-0.02mm.

East Coast Shielding & Instrument Plastics Limited can also offer very high thickness tolerance sheets on request with a tolerance of +/-0.025mm.

OPTOLITE ACRYLIC

Optolite Acrylic is another form of plastic that is optically clear and gives excellent contrast to any display. This product can be cast in custom sheet thickness ranging from 0.5mm to 8mm. Optolite Acrylic is available as a clear casting or in any shade/tint of a specified color desired. The sheets can be cast with various non glare finishes to one or both faces if required. Hard coatings can also be applied on request.

Thickness tolerance is +/-0.2mm.

SHIELDED OPTOLITE HSR AND SHIELDED OPTOLITE ACRYLIC

East Coast Shielding & Instrument Plastics Limited offer a range of highly effective RFI and EMI shielded window options. Shielded Optolite windows incorporate a micro fine wire mesh that is cast into each sheet. The mesh diameter ranges from 0.001" to 0.002". We also offer 50 OPI, 80 OPI, 100 OPI meshes in a blackened copper or blackened stainless steel.

The wire mesh can be angled to prevent pixel fringing on certain displays. It is also possible to offset the mesh in a cast window if needed. Each shielded window is edge terminated with a conductive busbar. The Optolite window can be cast in custom sheet thickness ranging from 1.0mm to 8mm. Non glare finishes can be cast into one or both surfaces if required.

OPTICAL Filters For Electronic Displays

ECS180 Series

OPTOLITE™ IR. INFRA-RED FILTERS

Optolite IR (infra-red) broadband acrylic filters have been specially formulated to transmit infra red radiation at wavelengths greater than approximately 750nm and are thereby virtually opaque to visible light.

Optolite IR (infra red) is eminently suitable for use in photometric systems which are triggered by near infra red signals but which must operate in environments with high levels of visible radiation. Optolite IR (infra-red) eliminates the visible spectrum and so improves the effectiveness of the system by increasing the signal-to-noise ratio. Specific applications include remote controls, security systems, presence sensing devices, proximity sensors and scanners.

Optolite IR Transmission Characteristics

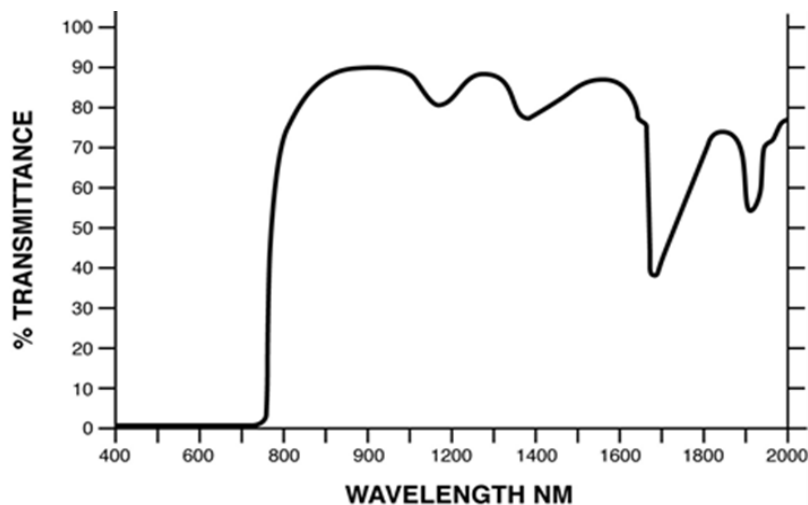

Features include:

- **Excellent Transmittance** up to a maximum of approximately 90% in the infra red region from 850nm—2000nm, 50% transmission at 780nm and effectively 0% below 740nm in the visible spectrum.
- **Cast-in Non-Glare Finish** available as an option to cut down any unwanted front surface reflections.
- **Filters supplied to Customer Drawings** in standard thickness of 0.5, 1.0, 1.5, 2.0, 3.0mm. Other, non-standard thicknesses and tight tolerances can be supplied to order.
- **EMC/RFI Shielded Filters** in Optolite IR Acrylic with encapsulated mesh are also available.

OPTICAL Filters For Electronic Displays

ECS180 Series

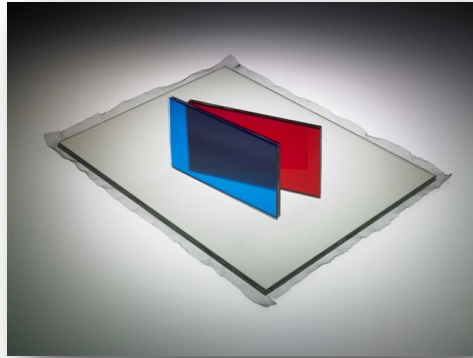

PLASTIC & GLASS LAMINATED FILTERS

Instrument Plastics Limited has invested in a new state of the art laminating facility and can now manufacture small as well as large laminated filters and windows in polycarbonate or glass. The maximum size of a shielded filter that can be laminated is 1900mm x 1100mm (48"x27") with a mesh set at 90 degrees. The maximum non shielded window that we can offer is 200mm x 1500mm (50"x38") . Laminations of fine wire mesh for shielding application, colored optical films, laminated filters, laminated infra-red films laminated privacy films are all possible. Multi-layered laminations can also be fabricated for customer applications (e.g. MRI Scanners).

Various non-glare finishes are available in glass and polycarbonate as well as multi-layered coatings (anti-reflection, anti-fingerprint, ITO (Indium Tin Oxide), anti-Newton ring & bio-coatings). Laminated shielded windows can be edge terminated with a conductive busbar or a mesh flying lead.

LINEAR AND CIRCULAR POLARISING FILTERS

Linear & Circular polarizing sheets can be either laminated or cut to accurate shapes or sizes. The standard sheet size kept in stock is 1000mm x 430mm.

CLEAR CONDUCTIVE FOILS (ITO FOILS)

ITO (Indium Tin Oxide) is a clear conductive film used for shielding. The material comes in rolls approx. 30" wide and 0.175mm (0.006") thick. 4 Ohm, 8 Ohm and 15 Ohm foils are kept in stock in either standard or non-glare finishes. Other Ohm ratings are available on request. These films can be cut to required sizes and shapes on our precise CNC Zund machines. They can be supplied as sheets or as laminated panels.

PRIVACY AND LIGHT CONTROL FILMS

East Coast Shielding & Instrument Plastics Limited can provide 3M Privacy films for customer applications. These films are sheets of laminated material with micro-fine louvers encapsulated within. This material is specifically used when privacy is important in a display such as Data Entry or ATM machines. The screen can be viewed head on, but at approximately 40 degrees either side of head on, the screen goes blank. The material can be cut and fit to screens and laminated into glass or plastic displays.

DIFFUSION FILTERS

Light diffusion filters manufactured from Optolite HSR can be produced in thicknesses of 1mm (0.040"). Light transmission rates of 40% to 87% are available in 12 steps depending on the customer's needs.

OPTICAL Filters For Electronic Displays

ECS180 Series

Presenting the Optolite EmiShield Micromesh

As a leading manufacturer in bespoke filters, we at Instrument Plastics are always delighted to be able to present a new product to this ever-evolving market. Our latest design innovation has been specifically developed to revolutionize the playing field by redefining what you thought you knew about shielding performance and clarity.

The Optolite EmiShield is an optical solution developed primarily to suit the needs of the Avionics, Military and Medical industries. Representing the very best in design innovation, it encapsulates the needs of an increasingly demanding market and translates them into unequalled light transmission, peak clarity and incomparable noise reduction. Our rigorous development and testing procedures means we're proud to say that the Optolite EmiShield isn't just the best product of its type – it's also the smartest performing product developed for use from within today's highly competitive optical filter industry.

About EmiShields

Those in the know will be familiar with the uses and applications of EmiShield products. However, some of our customers may be interested to learn more about how these clever devices protect our electronic equipment from signal interference.

Because we live in an increasingly wireless world, our airwaves are becoming more and more polluted with wireless signals which can negatively affect the performance of any type of wireless device. Think about how your phone interferes with your radio – this is exactly the type of problem that can be solved by using an EmiShield. However, because our electronic devices are becoming increasingly sensitive and complex – especially when produced to meet the requirements of highly demanding industries such as aviation and the military – our shielding requirements have naturally evolved and must be addressed by rigorous innovations in the field of optical filter manufacturing.

The Benefits of the Optolite EmiShield Micromesh

Standard EmiShields would typically be coated with Indium Tin Oxide (ITO), which is designed to enhance conductivity whilst reducing glare. However, technological advancements have created the need for enhanced reduction methods that are capable of optimizing EmiShield performance without compromising on visibility. This is where our new Optolite EmiShield Micromesh comes in.

Scratch-resistant, durable and featuring a larger open area for enhanced light transmission, the Optolite Micromesh stands head-and-shoulders above the competition in quality of design, durability and conductivity. Offering greater clarity and shielding performance than its ITO-coated counterparts, it's ideal for use with laminated glass and plastic windows, as well as with electronic displays. Standard mesh windows would typically have a grey tint and therefore offer compromised visibility. Not so with the Optolite EmiShield Micromesh. Expect clear skies as far as the eye can see and detail so sharp you'd be forgiven for forgetting you were using any kind of shield – although the unparalleled performance of your electronic devices should be a dead giveaway.

The enhanced design of our brand new micromesh also removes the need for expensive bus bars on stepped windows, making it the most versatile and easy-to-install product of its kind and the best solution for when you need to maximize space whilst minimizing cost.

Conduct-O-Foam

ECS 200 Series

ECS standard 200-Series profile gaskets contain a closed cell foam core wrapped with a plated fabric. Our fabric-over-foam continuous strip gaskets have excellent shielding effectiveness (SE), high durability, low compression set and low resistance.

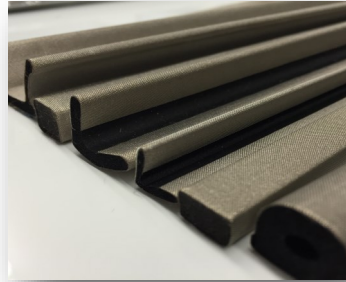
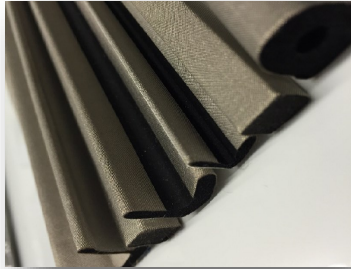

DESCRIPTION: Nylon Taffeta plated with Nickel over Copper, bonded to a Closed Cell foam EPDM core, with optional non-conductive pressure sensitive adhesive (PSA).

APPLICATIONS: EMI/RFI shielding.

TECHNICAL DATA

Conductive Fabric

Thickness	0.004 in (0.102mm)
Resistance	<0.05 ohm/sq
Shielding Effectiveness @ 1 GHz	75 – 90 dB

EPDM (Foam Core)

UL Rating	-
Compression Set	6 - 25%
Durometer (Shore 00)	50 – 60

PSA

Adhesive Thickness	0.003 in (0.076mm)
Adhesion (ASTM D3330-90 F)	
to Stainless Steel	
15 minutes RT:	49 oz/in (53 N/100mm)
72 hours RT	54 oz/in (57 N/100mm)
72 hours 158 F	68 oz/in (74 N/100mm)
Shear Strength (ASTM D3654)	
1000 grams @ 72 F	142 minutes
500 grams @ 158 F	1800 minutes

Conduct-O-FOAM

ECS 200 Series

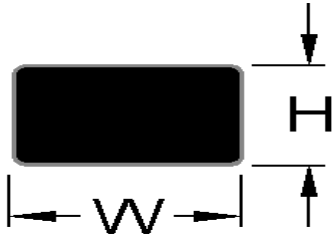

H (in.)	W (in.)	PART NO.
.118	.118	200-R118118-84
.200	.200	200-R200200-84
.236	.236	200-R236236-84
.315	.315	200-R31531584
.375	.375	200-R375375-84
.669	.669	200-R669669-84

.059	.197	200-059197-84
.059	.275	200-R059275-84
.059	.390	200-R059390-84
.059	.551	200-R059551-84
.079	.157	200-R079157-84
.079	.275	200-R079275-84
.079	.295	200-R079295-84
.079	.394	200-R079394-84
.125	.250	200-R125250-84
.125	.375	200-R125375-84
.125	.500	200-R125500-84
.130	.190	200-R130190-84
.157	.157	200-R157157-84
.250	.375	200-R250375-84
.250	.500	200-R250500-84
.375	.500	200-R375500-84
.375	1.000	200-3751000-84

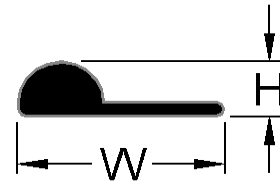

Profile	H	W
200-P1552-84	.150 (3.8mm)	.520 (13.2mm)
200-PXXXX-XX	Custom	Custom

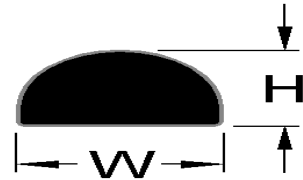

Profile	H	W
200-D1215-84	.120 (3.0mm)	.150 (3.8mm)
200-D1425-84	.140 (3.6mm)	.250 (6.4mm)
200-D2538-84	.250 (6.4mm)	.375 (9.5mm)



Profile	H	W
200-L3942-84	.385 (9.8mm)	.420 (10.7mm)
200-LXXXX-XX	Custom	Custom

We also offer a large array of profiles available upon request

Non-Conductive Silicone Rubber and Elastomers

ECS300 Series

East Coast Shielding offers a wide variety of rubber elastomers and cellular profiles to meet your application needs. Below you will find some general information about the characteristics and physical properties of many of our standard elastomers. For additional information about a specific elastomer, please contact us directly.

- Silicone
- Neoprene
- Sponge

Silicone:

- High Resistance to both high and low temperature extremes.
- Excellent weathering properties and resistance to ozone and oxygen attack..
- Long service life

Available in solid and cellular profiles.

Standard thickness (in.); solid silicone: 1/32 to 1/4; silicone sponge: 1/16 to 1/2

Other thicknesses available upon request (see section on Laminating)

Neoprene:

- Great all-purpose elastomer with resistance to ozone, sunlight, oxidation and various petroleum derivatives.
- Good resistance to water
- Good tensile strength properties
- May be blended to SBR to achieve a more economically priced material

Available in solid and cellular profiles.

Standard thickness (in.); solid neoprene: 1/32 to 1/2; neoprene sponge: 1/32 to 1

Other thicknesses available upon request (see section on Laminating)

Order with or without PSA (pressure sensitive adhesive).

Sponge:

Neoprene and Silicone are also available in sponge form. Closed cell sponge is preferred for applications requiring high compressibility. Open cell sponge is preferred for cushioning applications where sealing is an issue. The basic physical and chemical properties are the same as for the elastomers.



Non-Conductive Silicone Rubber and Elastomers

ECS300 Series Sponge & Solid Sizing

Thickness & Sheet Dimensions

Material

PSA



ECS300- _____ - _____ - _____

Series	Thickness	Sheet Dimensions	Material	PSA
ECS300	.032	24" x 24"	SP** SOL**	0** 1**
	.040			
	.045			
	.062	15" x 20"*		
	.093			
	.125	24" x 26"*		
	.188			
	.250			

* - 15 x 20 and 24 x 26 sheet dimensions only available for solid silicone

** - ADD : -SP for Sponge / -SOL for Solid / -0 for Plain / -1 For PSA Backing

For Example : ECS300-0622424-SP-1

SHIELDED VENT PANELS

ECS400 SERIES

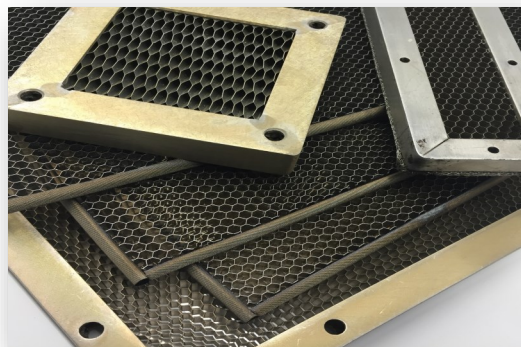
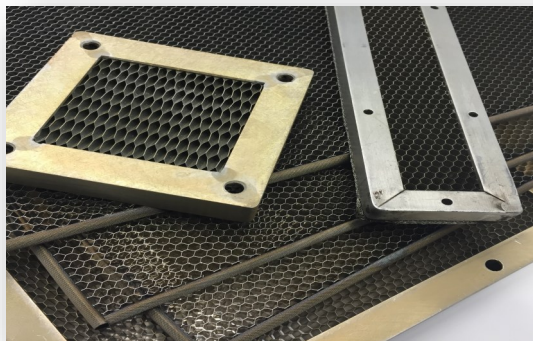

ECS400 aluminum shielded air vent panels are created from an aluminum honeycomb medium installed in an aluminum casing. The honeycomb allows for maximum levels of shielding while ensuring the least possible resistance to air flow.

APPLICATIONS

Recommended use for East Coast Shielding ECS 400 vents is to install into electric equipment enclosures that require high levels of EMI shielding as well as sufficient ventilation. East Coast Shielding vents can be installed necessitating on either the inlet or outlet air flows.

AVAILABLE CONFIGURATIONS

Our vents are typically assembled from 0.500" (12.70) thickness, 90-degree aluminum honeycomb with a cell size of 0.125" (3.18), but the honeycomb is also offered 0.250 (6.35) thickness and cell sizes of 0.062" (1.57) and 0.188" (4.78). Slanted cells are also available at 30, 45, and 60 degrees from the horizontal for drip proof construction. Vents with panels including captive inserts (with or without-holes) are available for mounting purposes. The finished construction can be chromate conversion coated or tin-plated for additional protection. East Coast Shielding vents are supplied with attached mesh, strip, or conductive silicon fabricated gaskets. For addi-

MATERIAL SPECIFICATIONS

Frame	Aluminum alloy 6063-T4 per QQ-A-200/8
Honeycomb	MIL-C-7438
Fastener	Aluminum captive insert, 8-32 UNC-3B
Chromate Finish	MIL-C-5541C
Tin-Plating	MIL-T-10727

TYPICAL SHIELDING PERFORMANCE FOR .125 THK x .500 Thk VENT

HONEYCOMB FINISH	H-Field	E-FIELD	PLANE WAVE	PLANE WAVE
	100 KHZ	10 MHZ	1 GHZ	10GHZ
Chemical Film	40 dB	75 dB	60 dB	40 dB
Tin	70 dB	125 dB	100 dB	80 dB
Nickel	75 dB	130dB	115 Db	100 dB

SHIELDED VENT PANELS

ECS400 SERIES

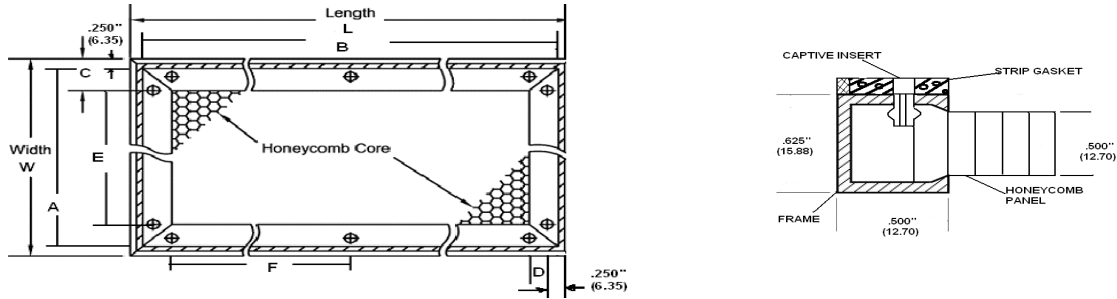

OVERALL DIMENSIONS		EFFECTIVE AIR FLOW AREA			FRAME DIMENSIONS		HOLE SPACING		NO. FASTENERS		Part No	Part No	Part No
							SIDE (W)	SIDE (L)	SIDE	SIDE	Std. 8.32	Std. .204	No Holes
W	L	IN (CM)	A	B	C	D	E	F	W	L	Fasteners	Holes	Fasteners
3(76.20)	3(76.20)	4 (25.81)	2(50.80)	2(50.80)	1.25(31.75)	1.25	-	-	1	1	ECS400-10	ECS400-11	ECS400-12
4(101.60)	4(101.60)	9(58)	3(76.20)	3(76.20)	1.75(44.45)	1.75 (44.45)	-	-	1	1	ECS400-13	ECS400-14	ECS400-15
4(101.60)	6(152.40)	15(97)	3(76.20)	5(127.00)	1.75(44.45)	1.00 (25.40)	3.50(88.90)		1	2	ECS400-16	ECS400-17	ECS400-18
4(101.60)	8(203.20)	21(135)	3(76.20)	7(177.80)	1.75(44.45)	0.75 (19.05)	-3.00(76.20)		1	3	ECS400-19	ECS400-20	ECS400-21
4(101.60)	12(304.80)	33(213)	3(76.20)	11(279.40)	1.75(44.45)	1.25 (31.75)	3.00(76.20)		1	4	ECS400-22	ECS400-23	ECS400-24
5(127.00)	5(127.00)	16(103)	4(101.60)	4(101.60)	2.25(57.15)	0.75 (19.05)	3.00(76.20)		1	2	ECS400-25	ECS400-26	ECS400-27
5(127.00)	7(177.80)	24(155)	4(101.60)	6(152.40)	2.25(57.15)	1.50 (38.10)	3.50(88.90)		1	2	ECS400-28	ECS400-29	ECS400-30
5(127.00)	10(254.00)	36(232)	4(101.60)	9(228.60)	2.25(57.15)	1.25 (31.75)	3.50(88.90)		1	3	ECS400-31	ECS400-32	ECS400-33
6(152.40)	6(152.40)	25(161)	5(127.00)	5(127.00)	1.00(25.40)	1.00 (25.40)	3.50(88.90)	3.50(88.90)	2	2	ECS400-34	ECS400-35	ECS400-36
6(152.40)	8(203.20)	35(226)	5(127.00)	7(177.80)	1.25(31.75)	0.75 (19.05)	3.00(76.20)	3.00(76.20)	2	3	ECS400-37	ECS400-38	ECS400-39
6(152.40)	12(304.80)	55(355)	5(127.00)	11(279.40)	1.00(25.40)	1.25 (31.75)	3.00(76.20)	3.50(88.90)	2	4	ECS400-41	ECS400-42	ECS400-43
6(152.40)	18(457.20)	85(548)	5(127.00)	17(431.80)	1.00(25.40)	1.25 (31.75)	3.75(95.25)	3.50(88.90)	2	5	ECS400-44	ECS400-45	ECS400-46
7(177.80)	7(177.80)	36(232)	6(152.40)	6(152.40)	1.50(38.10)	1.50 (38.10)	3.50(88.90)	3.50(88.90)	2	3	ECS400-47	ECS400-48	ECS400-49
7(177.80)	10(254.00)	54(348)	6(152.40)	9(228.60)	1.50(38.10)	1.25 (31.75)	3.50(88.90)	3.50(88.90)	2	3	ECS400-50	ECS400-51	ECS400-52
7(177.80)	14(355.60)	78(503)	6(152.40)	13(330.20)	1.50(38.10)	1.50 (38.10)	3.50(88.90)	3.50(88.90)	2	4	ECS400-53	ECS400-54	ECS400-55
8(203.20)	8(203.20)	49(316)	7(177.80)	7(177.80)	2.00(50.80)	0.75 (19.05)	3.00(76.20)	3.50(88.90)	2	3	ECS400-56	ECS400-57	ECS400-58
8(203.20)	12(304.80)	77(497)	7(177.80)	11(279.40)	0.75(19.05)	1.25 (31.75)	3.00(76.20)	3.00(76.20)	3	4	ECS400-59	ECS400-60	ECS400-61
8(203.20)	16(406.40)	105(677)	7(177.80)	15(381.00)	0.75(19.05)	1.25 (31.75)	3.250(82.55)	3.00(76.20)	3	5	ECS400-62	ECS400-63	ECS400-64
10(254.00)	10(254.00)	81(522)	9(228.60)	9(228.60)	1.25(31.75)	1.25 (31.75)	3.50(88.90)	3.50(88.90)	3	3	ECS400-65	ECS400-66	ECS400-67
10(254.00)	14(355.60)	117(755)	9(228.60)	13(330.20)	1.25(31.75)	1.50 (38.10)	3.50(88.90)	3.50(88.90)	3	4	ECS400-68	ECS400-69	ECS400-70
10(254.00)	18(457.20)	153(987)	9(228.60)	17(431.80)	1.25(31.75)	1.25 (31.75)	3.75(95.25)	3.50(88.90)	3	5	ECS400-71	ECS400-72	ECS400-73
12(304.80)	12(304.80)	121(780)	11(279.40)	11(279.40)	1.25(31.75)	1.25 (31.75)	3.00(76.20)	3.00(76.20)	4	4	ECS400-74	ECS400-75	ECS400-76
12(304.80)	16(406.40)	165(1064)	11(279.40)	15(381.00)	1.25(31.75)	1.25 (31.75)	3.25(82.55)	3.00(76.20)	4	5	ECS400-77	ECS400-78	ECS400-79
12(304.80)	20(508.00)	209(1348)	11(279.40)	19(482.60)	1.25(31.75)	1.00 (25.40)	3.50(88.90)	3.00(76.20)	4	6	ECS400-80	ECS400-81	ECS400-82
12(304.80)	24(609.60)	253(1632)	11(279.40)	23(584.20)	1.25(31.75)	1.25 (31.75)	3.50(88.90)	3.00(76.20)	4	7	ECS400-83	ECS400-84	ECS400-85

Conduct-O-Bond ECS2000

Technical Data Sheet

Conduct-o-Bond ECS2000

Electrically Conductive Adhesive

Conduct-o-Bond 2000 is a one part, silicone base, electrically conductive adhesive containing micron sized Nickel Coated Graphite particles as the conducting and shielding media. **ECS Conduct-o-Bond 2000** is a room temperature vulcanizing (RTV) and sealing material that cures in the presence of atmospheric moisture. This adhesive is specially formulated with a high quality non-corrosive silicone material that meets the requirements of MIL-A-46146, and will form a cured skin within 60 minutes after exposure to atmospheric moisture without the formation of corrosive by-products. This material will remain flexible and conductive and can be used in environments where temperatures range from -60 to +350° F without degradation of physical or electrical properties. **ECS Conduct-o-Bond 2000** is a thixotropic paste that can be applied to vertical surfaces without sagging. **ECS Conduct-o-Bond 2000** can be used for form-in-place conductive gasketing to attach shielding windows to frames or bezels, bonding conductive elastomer gaskets, and for providing



Elastomer Adhesive	Silicone
Filler Material:	Nickel Coated Graphite
Color:	Dark Grey

Specific Gravity	(+/-0.25)	2.010	ASTM D792
Hardness (Shore A)	(+/-7)	65	ASTM D2240
Tensile Strength	(PSI)	Min. 500	ASTM D412
Elongation	(%)	Min. 100	ASTM D412
		Max. 300	
Peel Strength	(PPI)	Min. 4.0	ASTM D1876
Lap Shear	(PSI)	Min. 130	ASTM D1002
Upper Operating Temp.	(°F)	Max. +350	
Lower Operating Temp.	(°F)	Min. -60	ASTM D1329
Compression Deflection	(%)	Min. 2.5	ASTM D575
Tack Free		Min. 60	
Light Handling		Hrs. 12-24	
Full Cure		Hrs. 96-144	
Volume Resistivity, Ohm/cm		Max. .100	MIL-DTL-83528 Para. 4.6.11
Shelf Life, From Date Of Shipment In		Months 6	

Conduct-O-Bond

ECS5000

Technical Data Sheet

Conduct-o-Bond ECS5000

Electrically Conductive Adhesive

Conduct-o-Bond 5000 is a one part, silicone elastomer base, electrically conductive adhesive containing micron sized Silver Plated Aluminum particles as the conducting and shielding media. **ECS Conduct-o-Bond 5000** is a room temperature vulcanizing (RTV) and sealing material that cures in the presence of atmospheric moisture. This adhesive is specially formulated with a high quality non-corrosive silicone material that meets the requirements of MIL-A-46146, and will form a cured skin within 60 minutes after exposure to atmospheric moisture without the formation of corrosive by-products. This material will remain flexible and conductive and can be used in environments where temperatures range from -60 to +350° F without degradation of physical or electrical properties. **ECS Conduct-o-Bond 5000** is a thixotropic paste that can be applied to vertical surfaces without sagging. **ECS Conduct-o-Bond 5000** can be used for form-in-place conductive gasketing to attach shielding windows to frames or bezels, bonding conductive elastomer gaskets, and for providing EMI and environmental protection as a sealant. ECS Conduct-o-Bond 5000 works especially well in harsh environments where corrosion is a concern. Also available with passivated silver aluminum particulates for extra corrosion protection.



Attach shielding windows to frames or bezels, bonding conductive elastomer gaskets, and for providing EMI and environmental protection as a sealant. ECS Conduct-o-Bond 5000 works especially well in harsh environments where corrosion is a concern. Also available with passivated silver

Elastomer Adhesive	Silicone
Filler Material:	Silver Plated Aluminum
Color:	Tan

aluminum particulates for extra corrosion protection.

Ask about oth-

Specific Gravity	(+/-0.25)		1.85	ASTM D792
Hardness (Shore A)	(+/-7)		70	ASTM D2240
Tensile Strength	(PSI)	Min.	260	ASTM D412
Elongation	(%)	Min.	100	ASTM D412
Peel Strength	(PPI)	Min.	4.0	ASTM D1876
Lap Shear	(PSI)	Min.	175	ASTM D1002
Upper Operating Temp.	(°F)	Max.	+350	
Lower Operating Temp.	(°F)	Min.	-60	ASTM D1329
Compression Deflection	(%)	Min.	2.5	ASTM D575
Tack Free		Min.	60	
Light Handling		Hrs.	12-24	
Full Cure		Hrs.	96-144	
Volume Resistivity, Ohm/cm		Max.	.009	MIL-DTL-83528 Para. 4.6.10
Shelf Life, From Date Of Shipment In		Months	6	

Performance of electrically conductive adhesives vary from one application to another. East Coast Shielding, Inc. cannot guarantee that the above specifications will be met in your application. If you need further assistance in evaluating your application, please do not hesitate to contact ECS for additional information.

ECS BOARD LEVEL SHIELDING

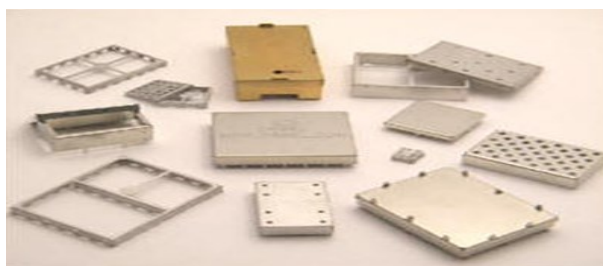

BASIC SHIELDING CANS

Basic PCB shielding cans provide low cost solutions to many RF/EMI shielding requirements. Basic cans may incorporate engagement tabs, trace/component relief, tuning/access openings, thermal relief and can be built to non-standard shapes as required. In cases where irregular shapes produce undesirable openings, inserts can be resistance welded into place. Corner seams can be resistance welded with the addition of internal flanges to increase performance. Typical cans, however, do not allow for the removal of the shield for rework since they are usually soldered directly to the PCB. When used in conjunction with mounted clips, basic cans can be removed and re-installed to provide access for rework and test requirements.

SINGLE-CAVITY SHIELD SETS

In cases where a more significant degree of access is required, a single cavity fence with a removable cover is recommended. Such fence and cover packages are designed to shield a single circuit area, with the fence soldered directly to the PCB, and a cover that can be removed and re-installed as required. Single cavity sets usually incorporate many products features and can be built in a wide range of footprint sizes and package heights. Versatile solutions providing unrestricted access and effective shielding performance for just about any circuit.

MULTI-CAVITY SHIELD SETS

To scale down the physical size and cost of a product, multi-cavity shields are often utilized to bring together a number of single cavity shields, which reduces the overall cost and footprint of the metalwork. Due to the complex nature of such designs and the related circuitry, multi-cavity designs have removable covers to allow access and a wide cross section of supporting features such as engagement tabs, trace/component relief, thermal relief, connectors, etc. It is possible to build multi-cavity fence sets from dozens of discreet components and having a proportionate number of cavities, opening up a world of design possibilities.





EAST COAST SHIELDING